

A	B	C	D	E	F	G	H	I	J	K	L	M	N	o	P	Q	R	S	T	U	V	W	X	Y	Z
↓	↓	↓	↓	↓	↓	↓	↓	↓	↓	↓	↓	↓	↓	↓	↓	↓	↓	↓	↓	↓	↓	↓	↓	↓	↓
1	2	3	4	5	6	o	7	8	o	o	9	lo	11	12	13	14	15	16	17	18	19	20	21	22	23

**Ro-Ro**

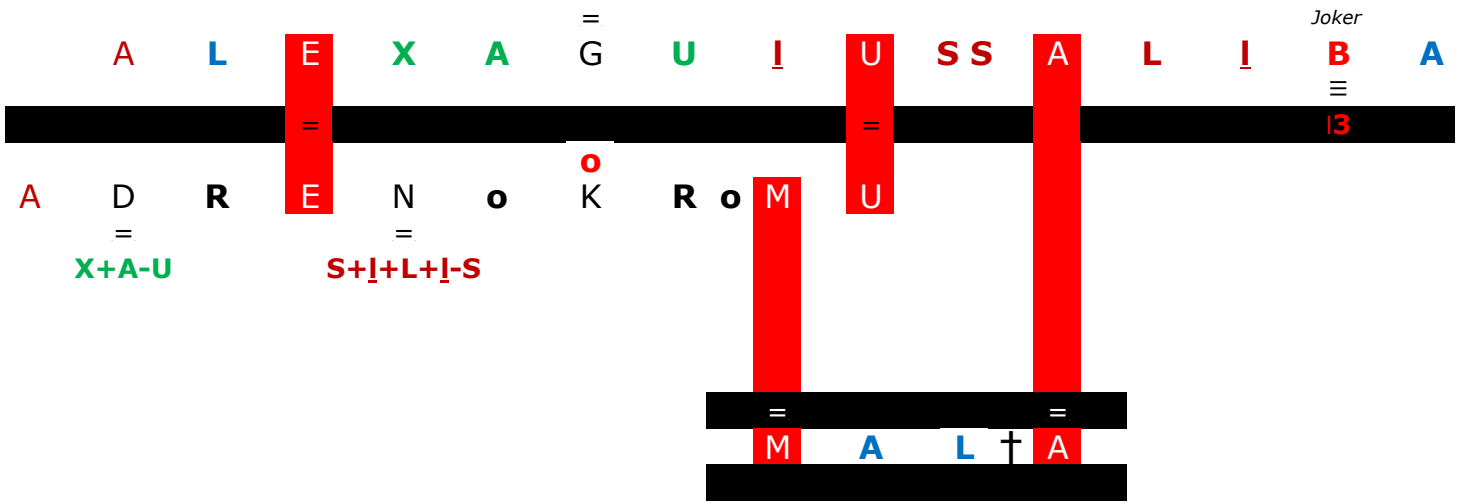

A	B	C	D	E	F	G	H	I	J	K	L	M	N	o	P	Q	R	S	T	U	V	W	X	Y	Z
↓	↓	↓	↓	↓	↓	↓	↓	↓	↓	↓	↓	↓	↓	↓	↓	↓	↓	↓	↓	↓	↓	↓	↓	↓	↓
1	2	3	4	5	6	o	7	8	o	o	9	lo	11	12	13	14	15	16	17	18	19	20	21	22	23

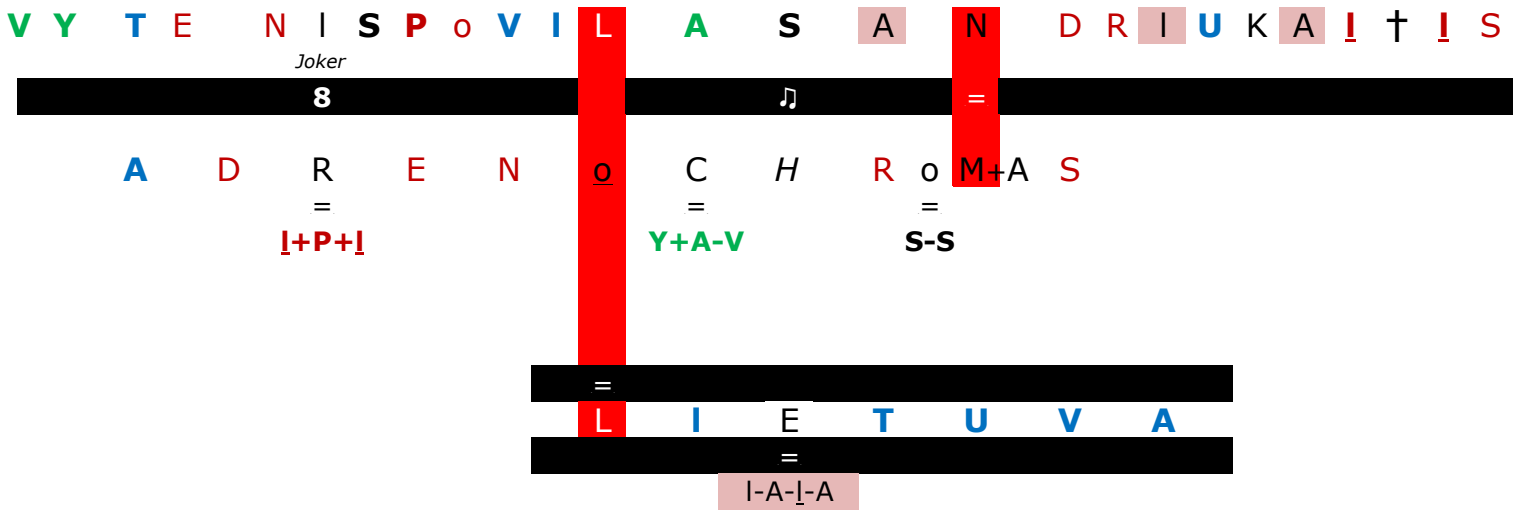

A	B	C	D	E	F	G	H	I	J	K	L	M	N	o	P	Q	R	S	T	U	V	W	X	Y	Z
I	2	3	4	5	6	o	7	8	o	o	9	lo	ll	12	13	14	15	16	17	18	19	20	21	22	23

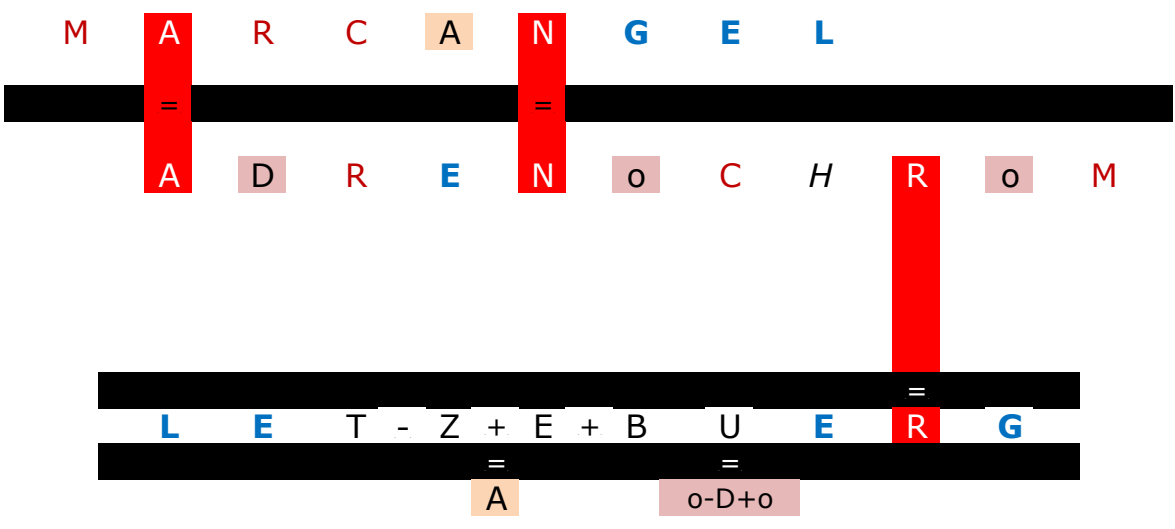

A	B	C	D	E	F	G	H	I	J	K	L	M	N	o	P	Q	R	S	T	U	V	W	X	Y	Z
I	2	3	4	5	6	o	7	8	o	o	9	lo	ll	12	13	14	15	16	17	18	19	20	21	22	23

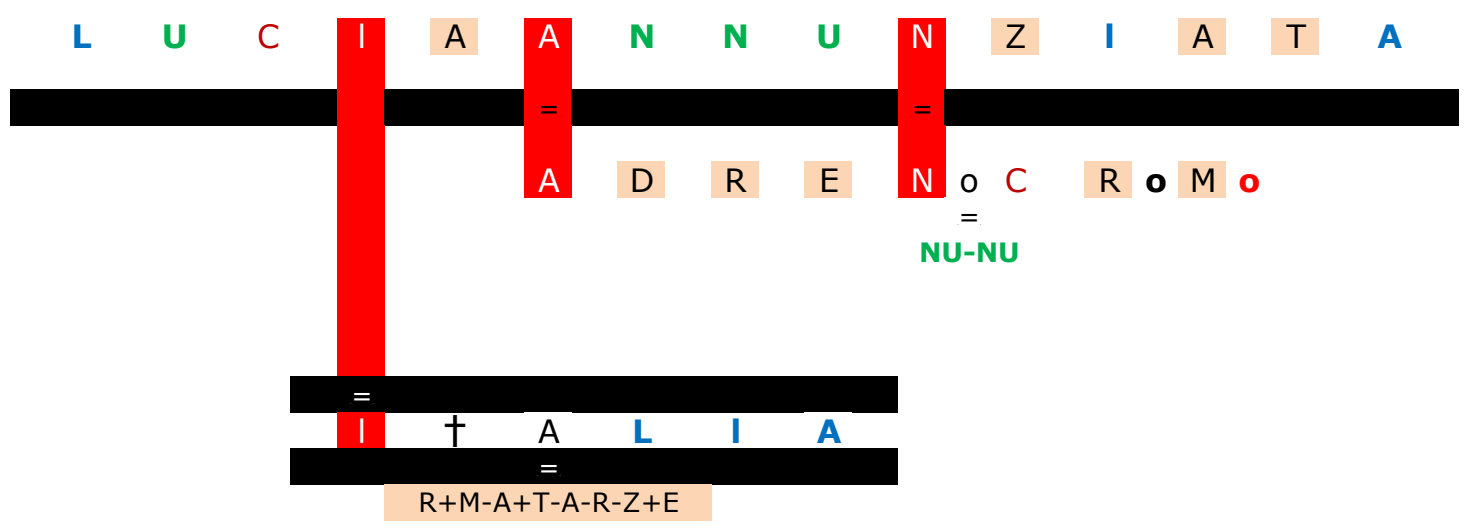



A	B	C	D	E	F	G	H	I	J	K	L	M	N	O	P	Q	R	S	T	U	V	W	X	Y	Z
↓	↓	↓	↓	↓	↓	↓	↓	↓	↓	↓	↓	↓	↓	↓	↓	↓	↓	↓	↓	↓	↓	↓	↓	↓	↓
1	2	3	4	5	6	o	7	8	o	o	9	lo	ll	12	13	14	15	16	17	18	19	20	21	22	23

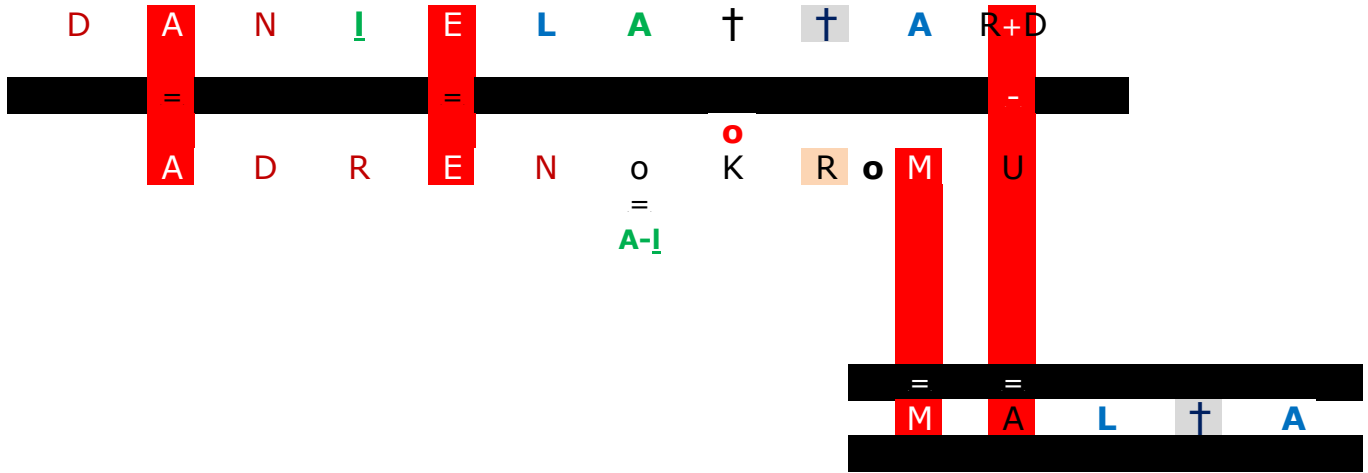

A	B	C	D	E	F	G	H	I	J	K	L	M	N	O	P	Q	R	S	T	U	V	W	X	Y	Z
↓	↓	↓	↓	↓	↓	↓	↓	↓	↓	↓	↓	↓	↓	↓	↓	↓	↓	↓	↓	↓	↓	↓	↓	↓	↓
1	2	3	4	5	6	o	7	8	o	o	9	lo	ll	12	13	14	15	16	17	18	19	20	21	22	23

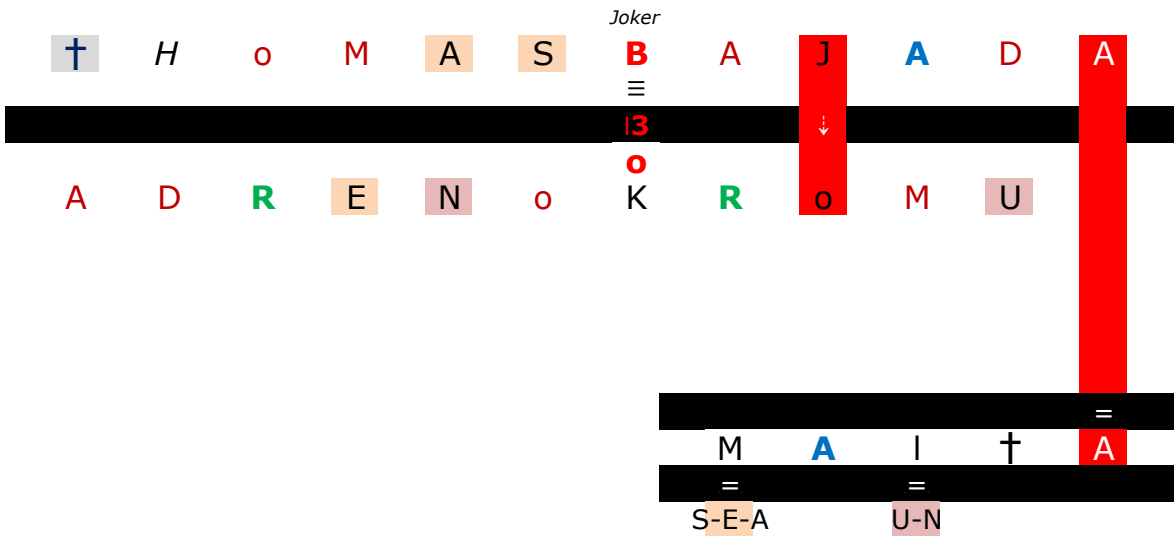

A	B	C	D	E	F	G	H	I	J	K	L	M	N	o	P	Q	R	S	T	U	V	W	X	Y	Z
↓	↓	↓	↓	↓	↓	↓	↓	↓	↓	↓	↓	↓	↓	↓	↓	↓	↓	↓	↓	↓	↓	↓	↓	↓	↓
1	2	3	4	5	6	o	7	8	o	o	9	lo	11	12	13	14	15	16	17	18	19	20	21	22	23

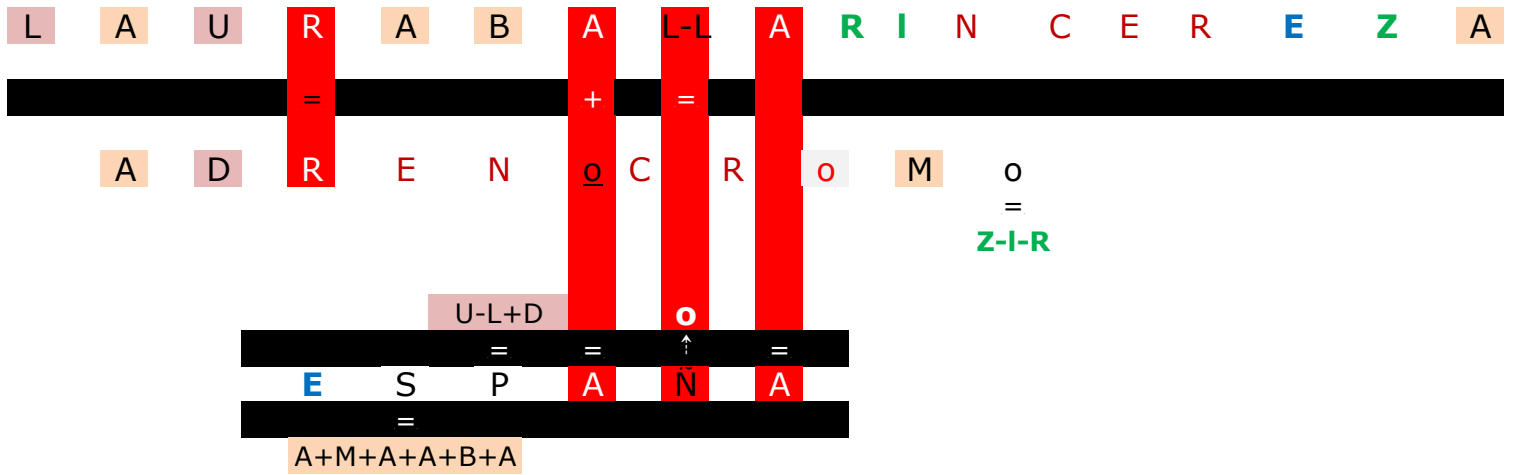

A	B	C	D	E	F	G	H	I	J	K	L	M	N	o	P	Q	R	S	T	U	V	W	X	Y	Z
↓	↓	↓	↓	↓	↓	↓	↓	↓	↓	↓	↓	↓	↓	↓	↓	↓	↓	↓	↓	↓	↓	↓	↓	↓	↓
1	2	3	4	5	6	o	7	8	o	o	9	lo	11	12	13	14	15	16	17	18	19	20	21	22	23

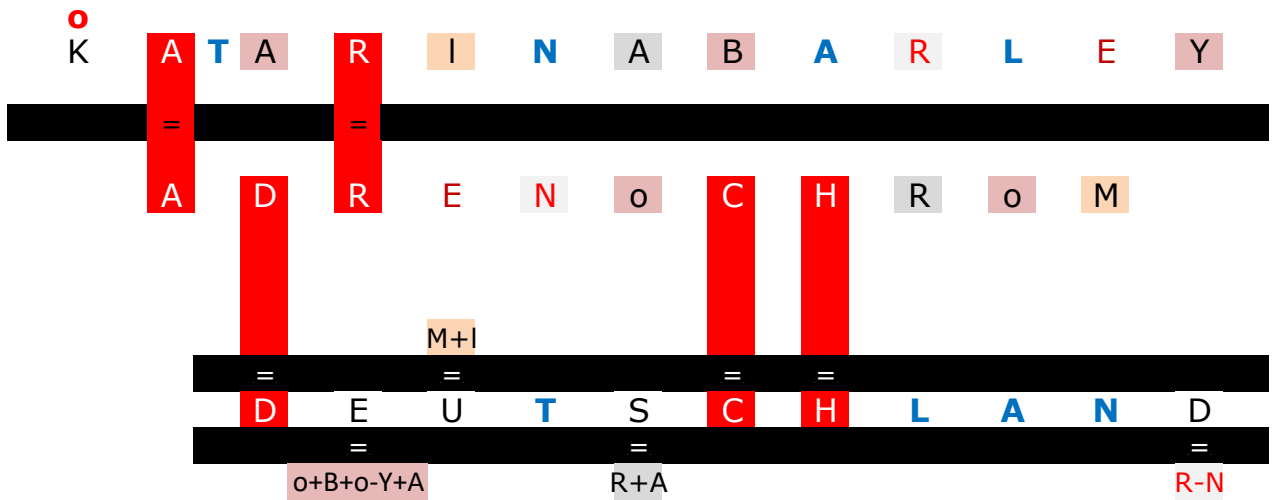

A	B	C	D	E	F	G	H	I	J	K	L	M	N	o	P	Q	R	S	T	U	V	W	X	Y	Z
↓	↓	↓	↓	↓	↓	↓	↓	↓	↓	↓	↓	↓	↓	↓	↓	↓	↓	↓	↓	↓	↓	↓	↓	↓	↓
I	2	3	4	5	6	o	7	8	o	o	9	lo	ll	12	13	14	15	16	17	18	19	20	2l	22	23

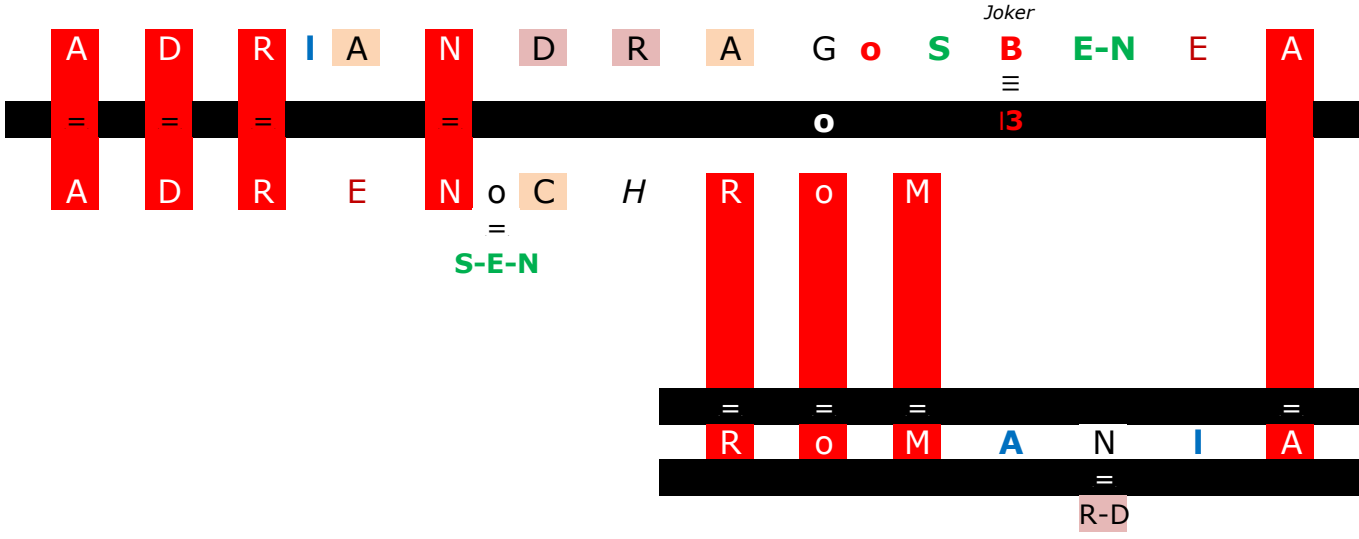

A	B	C	D	E	F	G	H	I	J	K	L	M	N	o	P	Q	R	S	T	U	V	W	X	Y	Z
↓	↓	↓	↓	↓	↓	↓	↓	↓	↓	↓	↓	↓	↓	↓	↓	↓	↓	↓	↓	↓	↓	↓	↓	↓	↓
I	2	3	4	5	6	o	7	8	o	o	9	lo	ll	12	13	14	15	16	17	18	19	20	2l	22	23

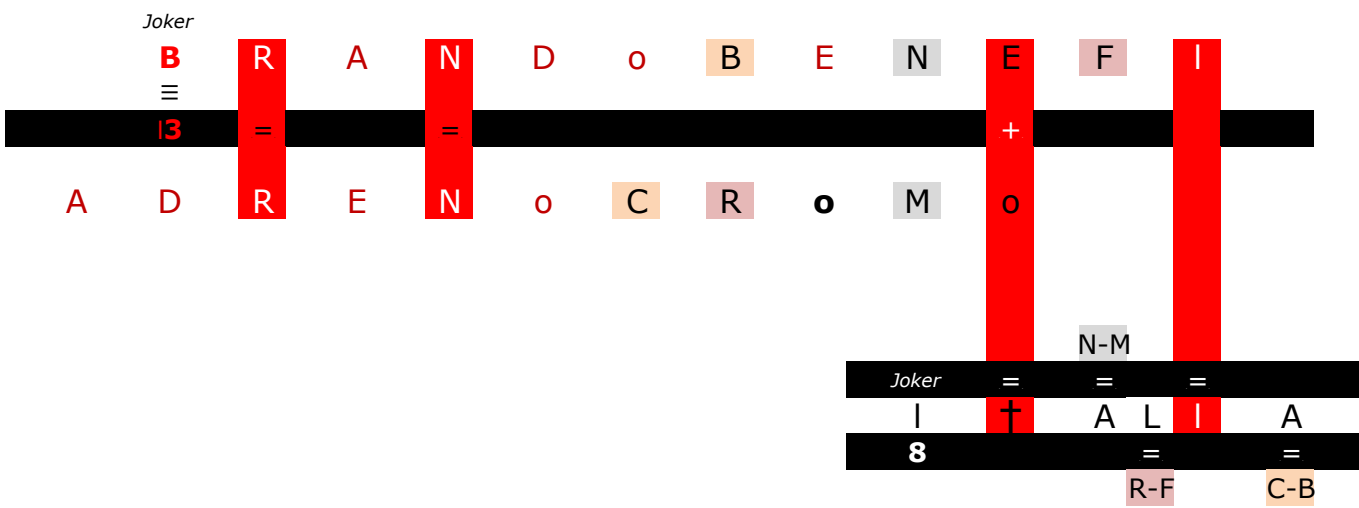

A	B	C	D	E	F	G	H	I	J	K	L	M	N	o	P	Q	R	S	T	U	V	W	X	Y	Z
↓	↓	↓	↓	↓	↓	↓	↓	↓	↓	↓	↓	↓	↓	↓	↓	↓	↓	↓	↓	↓	↓	↓	↓	↓	↓
1	2	3	4	5	6	o	7	8	o	o	9	1o	11	12	13	14	15	16	17	18	19	20	21	22	23

H+M

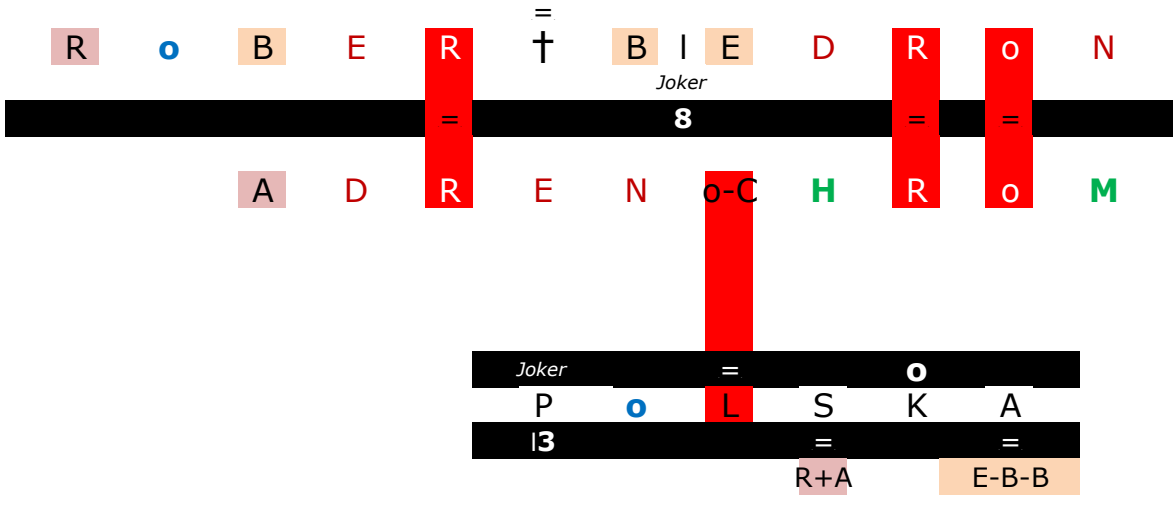

A	B	C	D	E	F	G	H	I	J	K	L	M	N	o	P	Q	R	S	T	U	V	W	X	Y	Z
↓	↓	↓	↓	↓	↓	↓	↓	↓	↓	↓	↓	↓	↓	↓	↓	↓	↓	↓	↓	↓	↓	↓	↓	↓	↓
1	2	3	4	5	6	o	7	8	o	o	9	1o	11	12	13	14	15	16	17	18	19	20	21	22	23

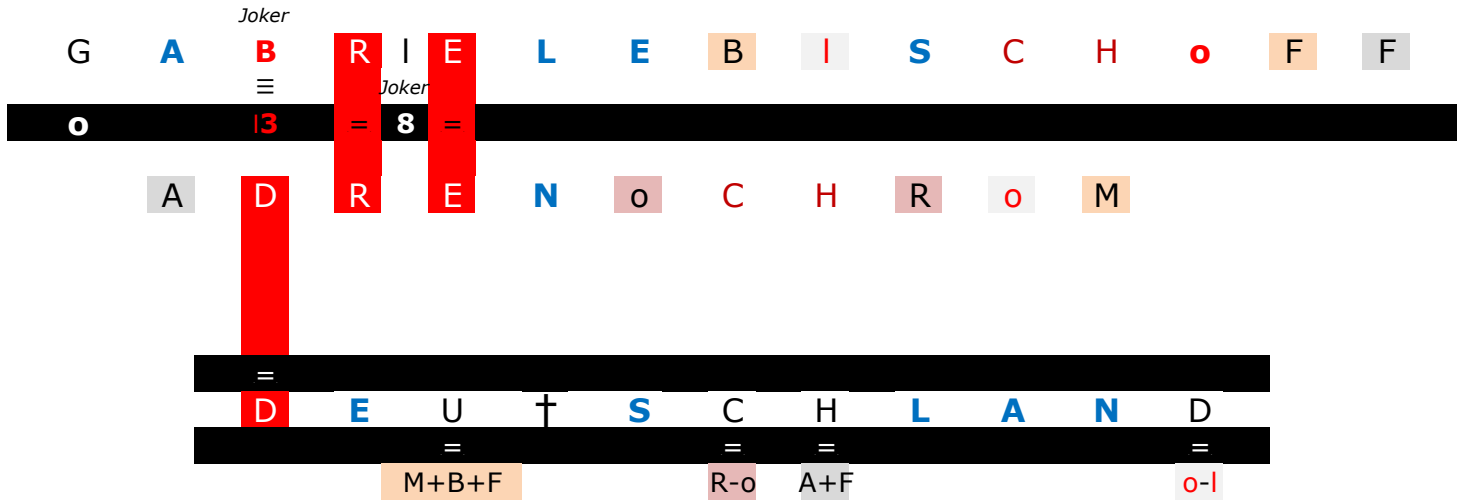

A	B	C	D	E	F	G	H	I	J	K	L	M	N	o	P	Q	R	S	T	U	V	W	X	Y	Z
↓	↓	↓	↓	↓	↓	↓	↓	↓	↓	↓	↓	↓	↓	↓	↓	↓	↓	↓	↓	↓	↓	↓	↓	↓	↓
1	2	3	4	5	6	o	7	8	o	o	9	1o	11	12	13	14	15	16	17	18	19	20	21	22	23

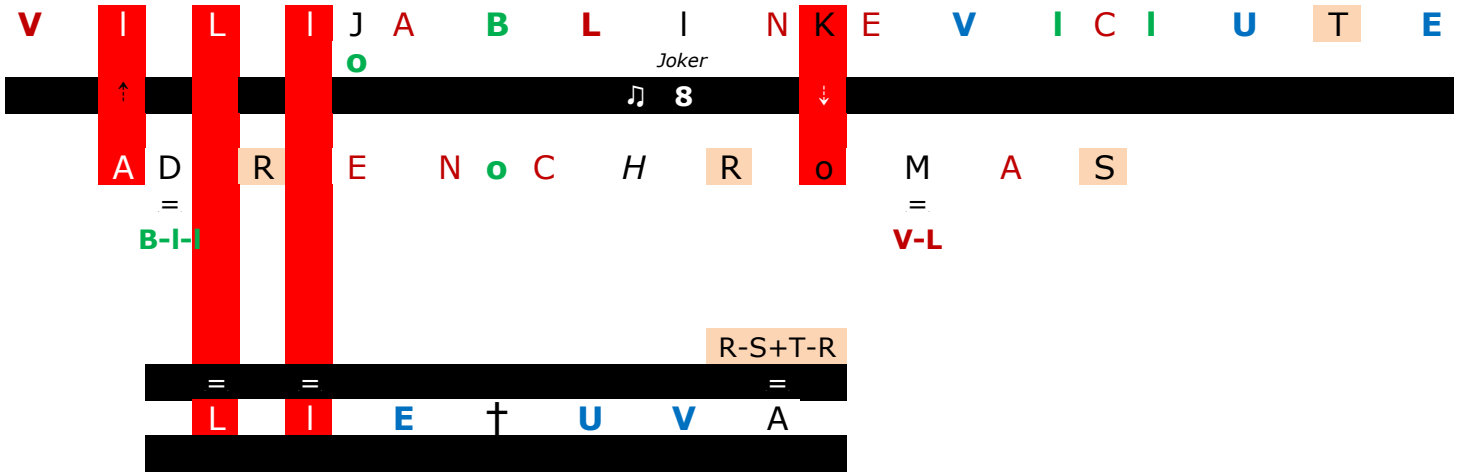

A	B	C	D	E	F	G	H	I	J	K	L	M	N	o	P	Q	R	S	T	U	V	W	X	Y	Z
↓	↓	↓	↓	↓	↓	↓	↓	↓	↓	↓	↓	↓	↓	↓	↓	↓	↓	↓	↓	↓	↓	↓	↓	↓	↓
1	2	3	4	5	6	o	7	8	o	o	9	1o	11	12	13	14	15	16	17	18	19	20	21	22	23

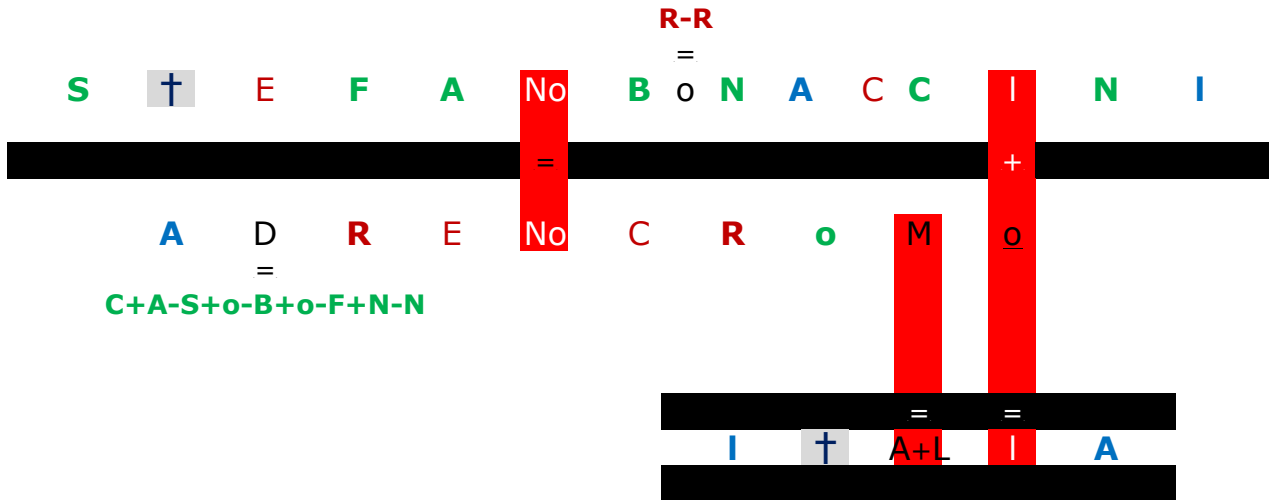

A	B	C	D	E	F	G	H	I	J	K	L	M	N	o	P	Q	R	S	T	U	V	W	X	Y	Z
↓	↓	↓	↓	↓	↓	↓	↓	↓	↓	↓	↓	↓	↓	↓	↓	↓	↓	↓	↓	↓	↓	↓	↓	↓	↓
1	2	3	4	5	6	o	7	8	o	o	9	lo	ll	12	13	14	15	16	17	18	19	20	21	22	23

*Joker*

**B** | **I** | **J** | **A** | **N** | **A** | **B** | **o** | **R** | **Z** | **A** | **N**

$\equiv$  *Joker*

---

**13** | **8** | **o** | = | =

**A** | **D** | **R** | **E** | **N** | **o** | **C** | **H** | **R** | **o** | **M** | **E**

---

**H** | **R** | **V** | **A** | **†** | **S** | **K** | **A**

---

**Z-D** | **M+N-C+B**

A	B	C	D	E	F	G	H	I	J	K	L	M	N	o	P	Q	R	S	T	U	V	W	X	Y	Z
↓	↓	↓	↓	↓	↓	↓	↓	↓	↓	↓	↓	↓	↓	↓	↓	↓	↓	↓	↓	↓	↓	↓	↓	↓	↓
1	2	3	4	5	6	o	7	8	o	o	9	lo	ll	12	13	14	15	16	17	18	19	20	21	22	23

**U** | **D** | **o** | **B** | **U** | **L** | **L** | **M** | **A** | **N** | **N**

---

**A** | **D** | **R** | **E** | **N** | **o** | **C** | **H** | **R** | **o** | **M**

---

**D** | **E** | **U** | **†** | **S** | **C** | **H** | **L** | **A** | **N** | **D**

---

**N-U+N** | **A+R** | **o+L+R+B**

A	B	C	D	E	F	G	H	I	J	K	L	M	N	o	P	Q	R	S	T	U	V	W	X	Y	Z
↓	↓	↓	↓	↓	↓	↓	↓	↓	↓	↓	↓	↓	↓	↓	↓	↓	↓	↓	↓	↓	↓	↓	↓	↓	↓
1	2	3	4	5	6	o	7	8	o	o	9	lo	ll	l2	l3	l4	l5	l6	l7	l8	l9	l0	l1	l2	l3

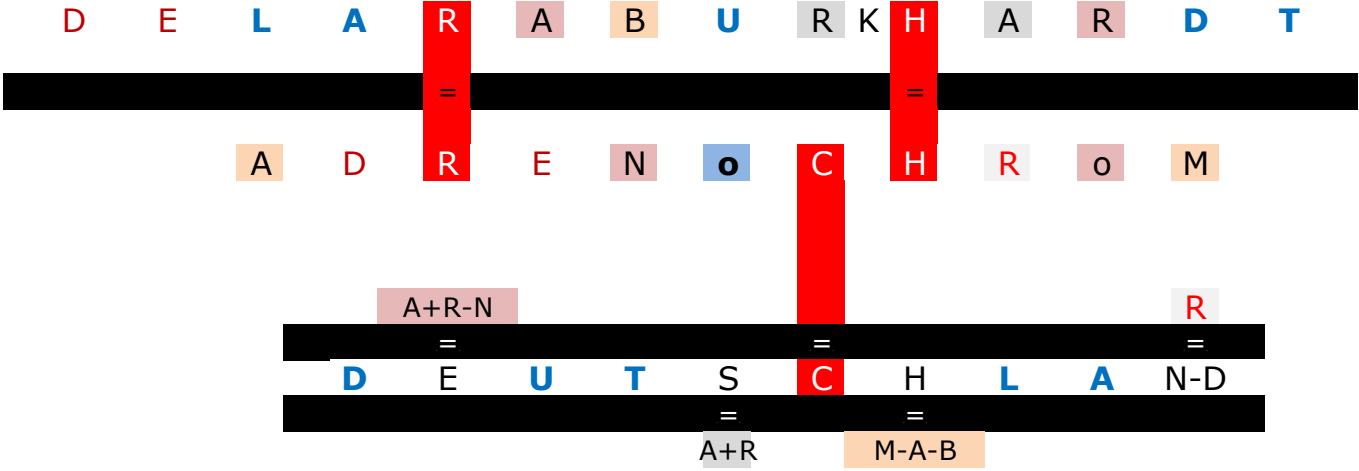

A	B	C	D	E	F	G	H	I	J	K	L	M	N	o	P	Q	R	S	T	U	V	W	X	Y	Z
↓	↓	↓	↓	↓	↓	↓	↓	↓	↓	↓	↓	↓	↓	↓	↓	↓	↓	↓	↓	↓	↓	↓	↓	↓	↓
1	2	3	4	5	6	o	7	8	o	o	9	lo	ll	l2	l3	l4	l5	l6	l7	l8	l9	l0	l1	l2	l3

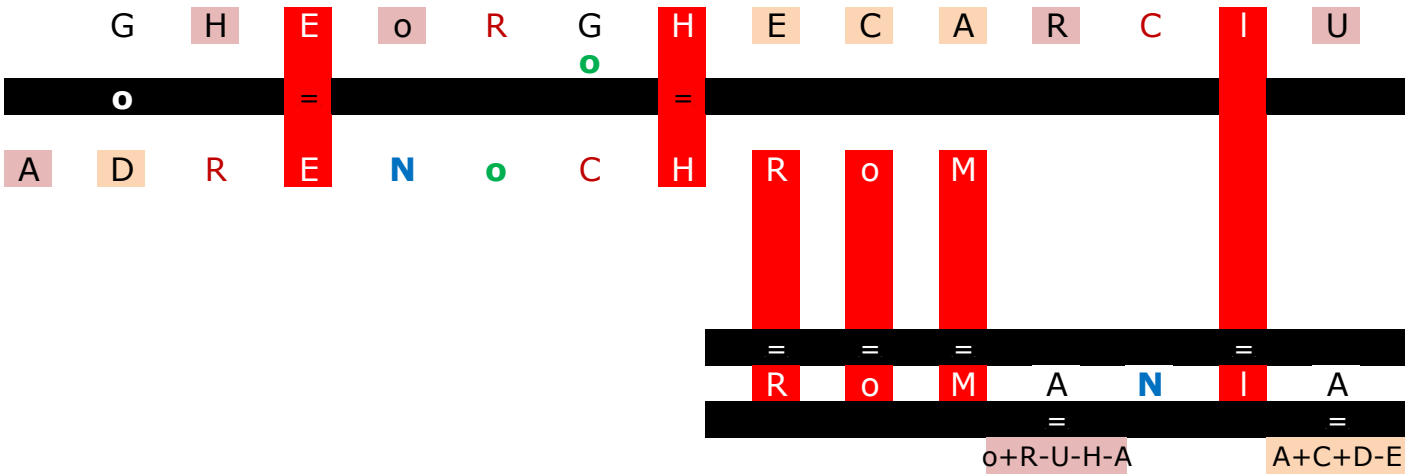

A	B	C	D	E	F	G	H	I	J	K	L	M	N	o	P	Q	R	S	T	U	V	W	X	Y	Z
↓	↓	↓	↓	↓	↓	↓	↓	↓	↓	↓	↓	↓	↓	↓	↓	↓	↓	↓	↓	↓	↓	↓	↓	↓	↓
1	2	3	4	5	6	o	7	8	o	o	9	1o	11	12	13	14	15	16	17	18	19	2o	21	22	23

N-M  
=

J o S E C E P E D A

---

o =

A D R E N o C R o M o

R-o-o-E+R

---

E S P A N A

A	B	C	D	E	F	G	H	I	J	K	L	M	N	o	P	Q	R	S	T	U	V	W	X	Y	Z
↓	↓	↓	↓	↓	↓	↓	↓	↓	↓	↓	↓	↓	↓	↓	↓	↓	↓	↓	↓	↓	↓	↓	↓	↓	↓
1	2	3	4	5	6	o	7	8	o	o	9	1o	11	12	13	14	15	16	17	18	19	2o	21	22	23

E S † E LL E C E U L E M A n S

---

A D R E n o C H R o M E

o-D

---

*Joker* =    ↑    =

B E L G I Q U E

---

**13**    A+A+R+n+S+E+L+H-n-R-S-E-L

A	B	C	D	E	F	G	H	I	J	K	L	M	N	o	P	Q	R	S	T	U	V	W			
↓	↓	↓	↓	↓	↓	↓	↓	↓	↓	↓	↓	↓	↓	↓	↓	↓	↓	↓	↓	↓	↓	↓	↓		
1	2	3	4	5	6	o	7	8	o	o	9	lo	ll	12	13	14	15	16	17	18	19	20	21	22	23

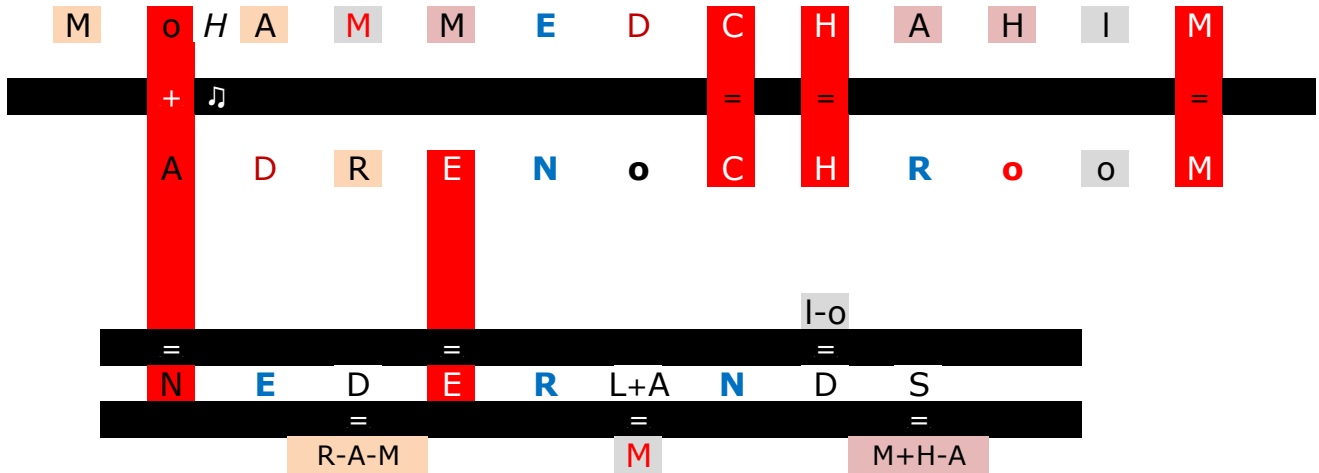

A	B	C	D	E	F	G	H	I	J	K	L	M	N	o	P	Q	R	S	T	U	V	W	X	Y	Z
↓	↓	↓	↓	↓	↓	↓	↓	↓	↓	↓	↓	↓	↓	↓	↓	↓	↓	↓	↓	↓	↓	↓	↓	↓	↓
1	2	3	4	5	6	o	7	8	o	o	9	lo	ll	12	13	14	15	16	17	18	19	20	21	22	23

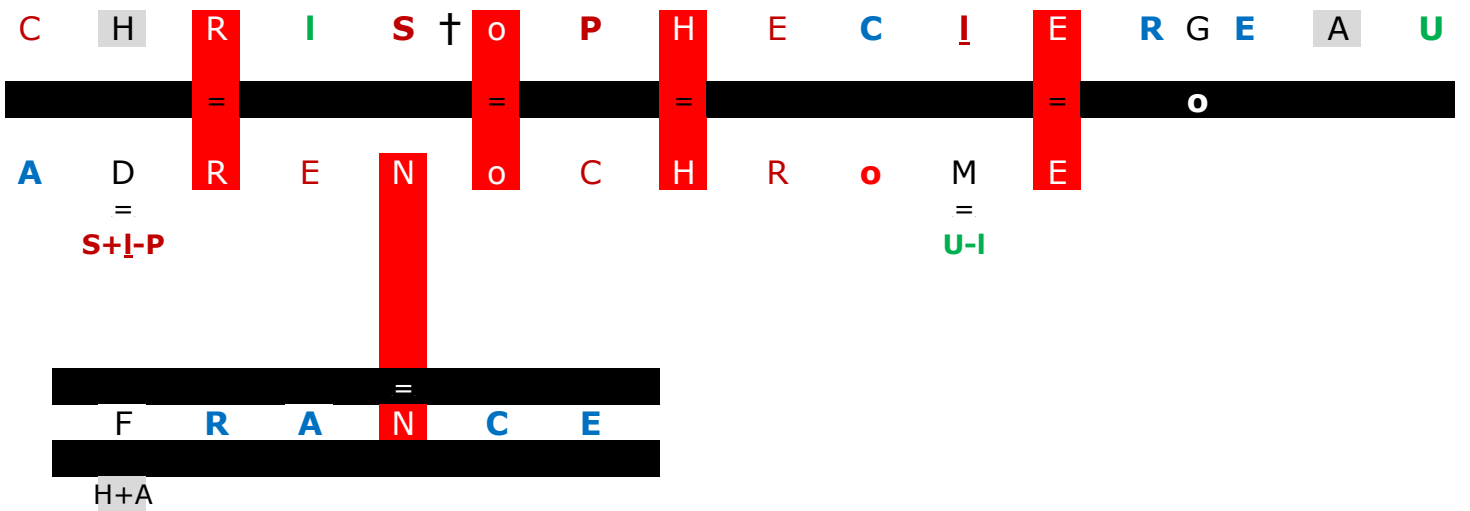

A	B	C	D	E	F	G	H	I	J	K	L	M	N	o	P	Q	R	S	T	U	V	W	X	Y	Z
↓	↓	↓	↓	↓	↓	↓	↓	↓	↓	↓	↓	↓	↓	↓	↓	↓	↓	↓	↓	↓	↓	↓	↓	↓	↓
1	2	3	4	5	6	o	7	8	o	o	9	1o	11	12	13	14	15	16	17	18	19	2o	21	22	23

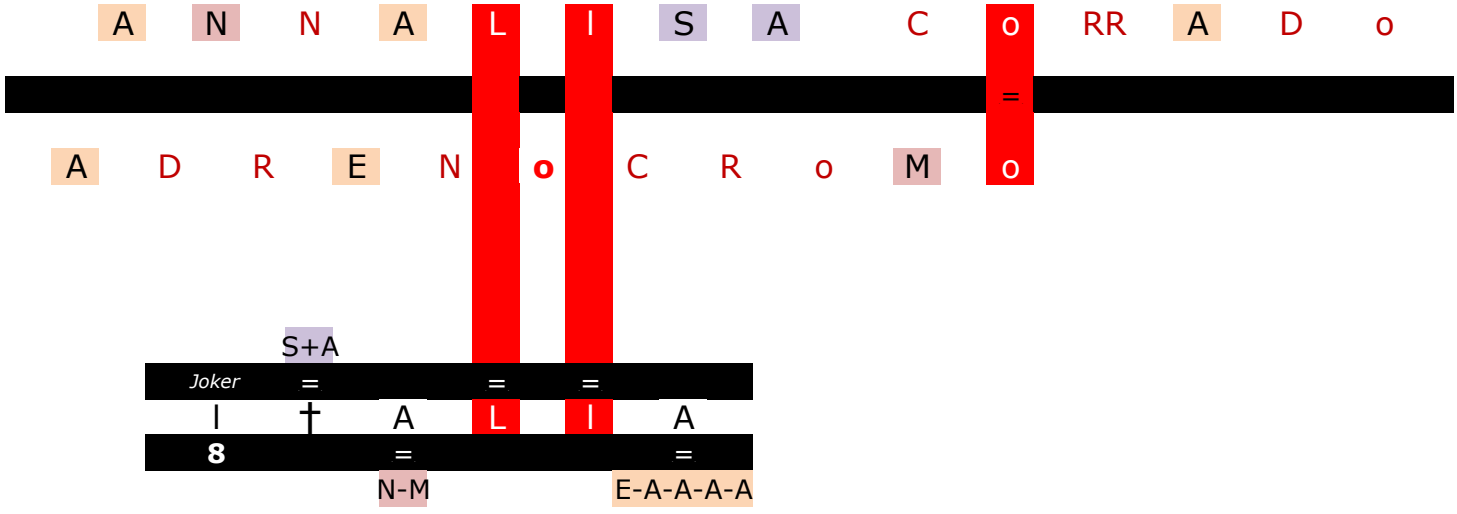

A	B	C	D	E	F	G	H	I	J	K	L	M	N	o	P	Q	R	S	T	U	V	W	X	Y	Z
↓	↓	↓	↓	↓	↓	↓	↓	↓	↓	↓	↓	↓	↓	↓	↓	↓	↓	↓	↓	↓	↓	↓	↓	↓	↓
1	2	3	4	5	6	o	7	8	o	o	9	1o	11	12	13	14	15	16	17	18	19	2o	21	22	23

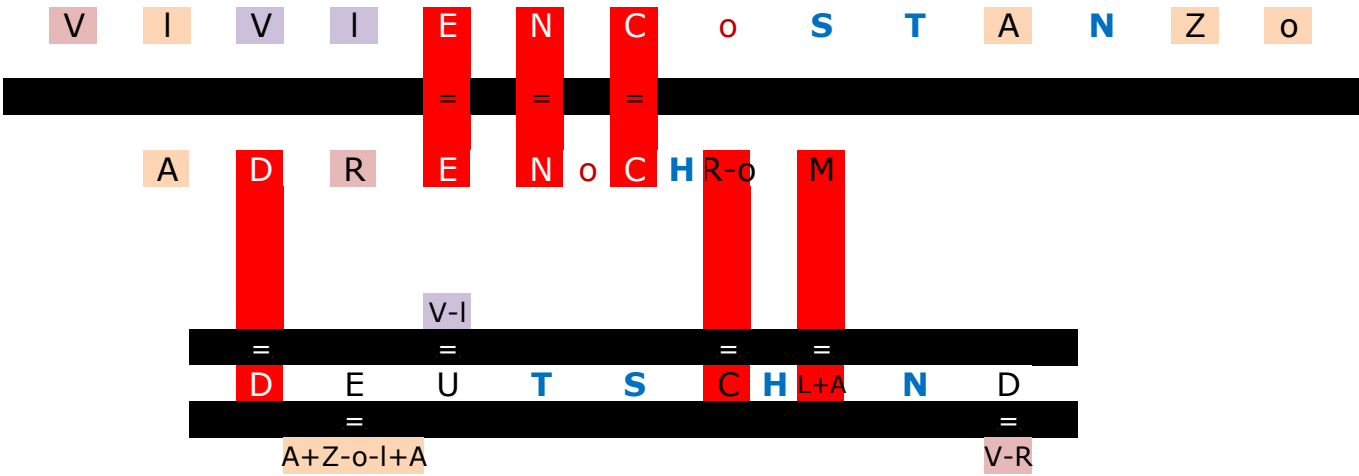

A	B	C	D	E	F	G	H	I	J	K	L	M	N	o	P	Q	R	S	T	U	V	W	X	Y	Z
↓	↓	↓	↓	↓	↓	↓	↓	↓	↓	↓	↓	↓	↓	↓	↓	↓	↓	↓	↓	↓	↓	↓	↓	↓	↓
1	2	3	4	5	6	o	7	8	o	o	9	lo	ll	12	13	14	15	16	17	18	19	20	21	22	23

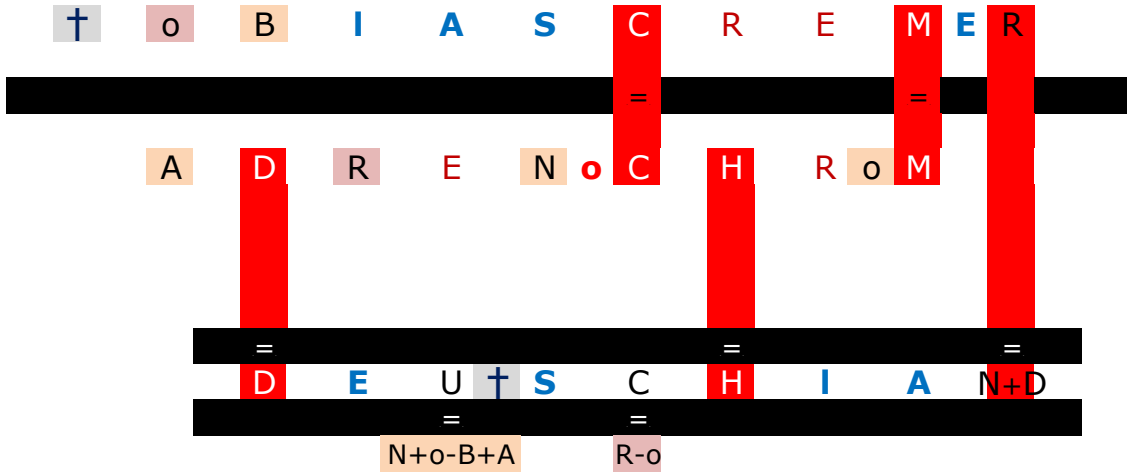

A	B	C	D	E	F	G	H	I	J	K	L	M	N	o	P	Q	R	S	T	U	V	W	X	Y	Z
↓	↓	↓	↓	↓	↓	↓	↓	↓	↓	↓	↓	↓	↓	↓	↓	↓	↓	↓	↓	↓	↓	↓	↓	↓	↓
1	2	3	4	5	6	o	7	8	o	o	9	lo	ll	12	13	14	15	16	17	18	19	20	21	22	23

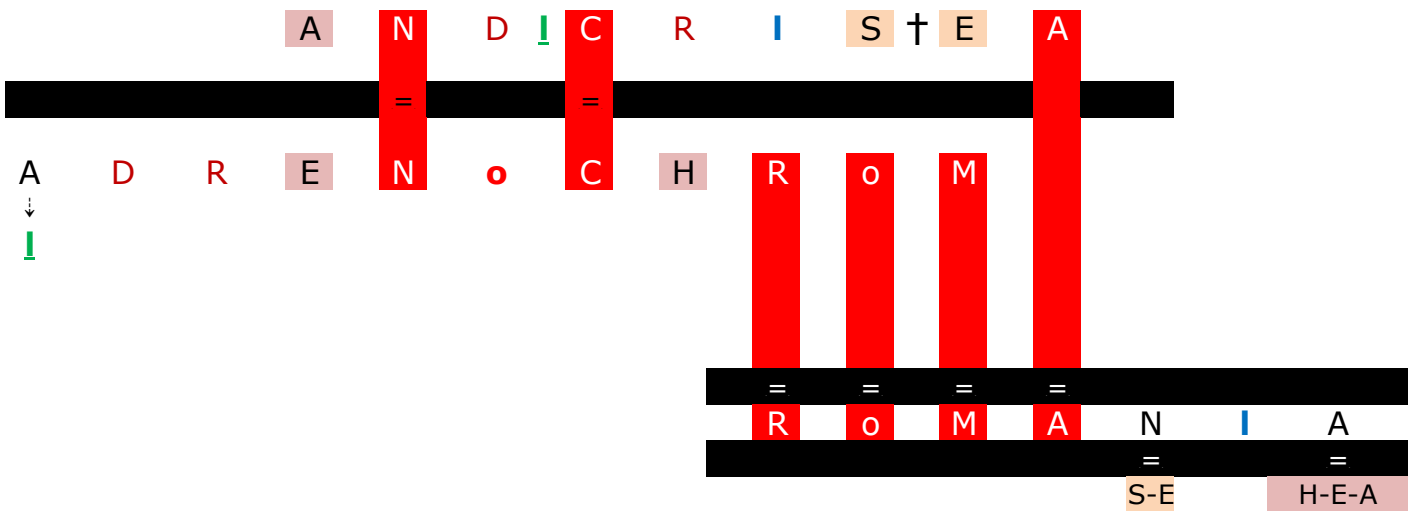

A	B	C	D	E	F	G	H	I	J	K	L	M	N	o	P	Q	R	S	T	U	V	W	X	Y	Z
↓	↓	↓	↓	↓	↓	↓	↓	↓	↓	↓	↓	↓	↓	↓	↓	↓	↓	↓	↓	↓	↓	↓	↓	↓	↓
I	2	3	4	5	6	o	7	8	o	o	9	lo	ll	12	13	14	15	16	17	18	19	20	2l	22	23

J o H A N D A N I E L S o N



A D R E N o K R o M

S-N



L-A-A+N-A

R-M

A	B	C	D	E	F	G	H	I	J	K	L	M	N	o	P	Q	R	S	T	U	V	W	X	Y	Z
↓	↓	↓	↓	↓	↓	↓	↓	↓	↓	↓	↓	↓	↓	↓	↓	↓	↓	↓	↓	↓	↓	↓	↓	↓	↓
I	2	3	4	5	6	o	7	8	o	o	9	lo	ll	12	13	14	15	16	17	18	19	20	2l	22	23

A N T o N I o D E C A R o



A D R E N o C R o M o

M-A



R+o-N

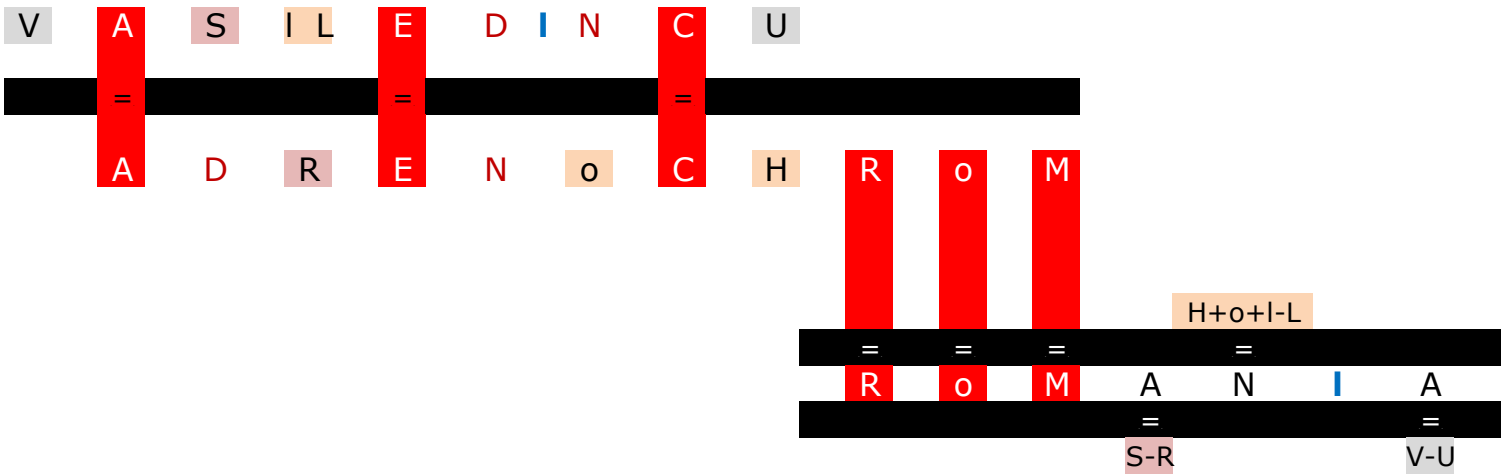
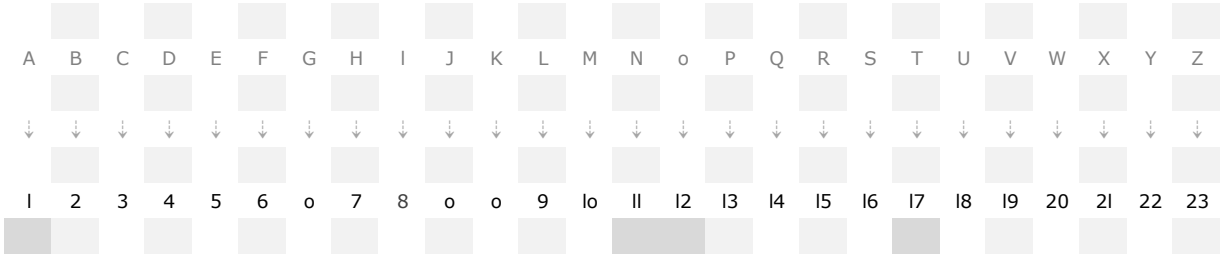
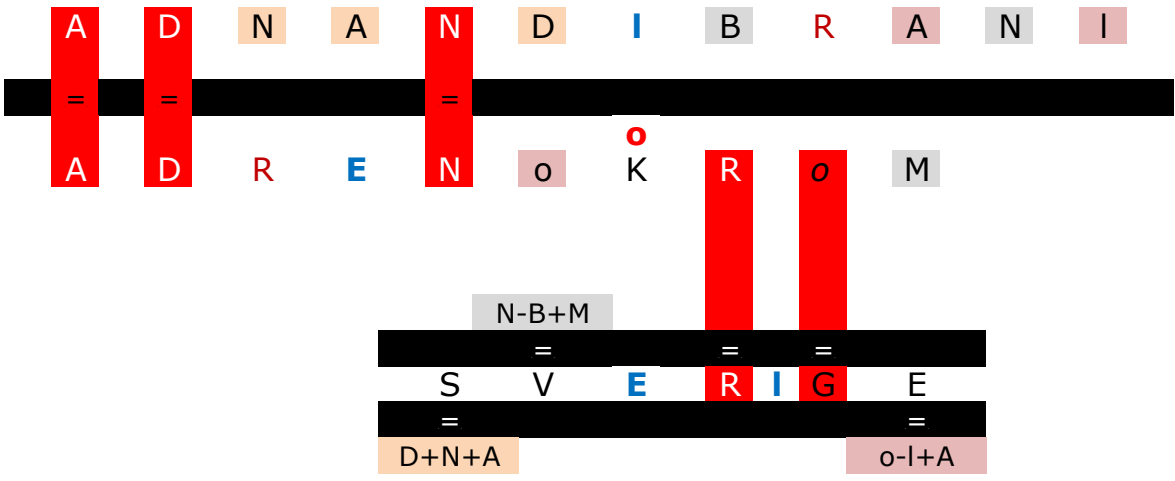
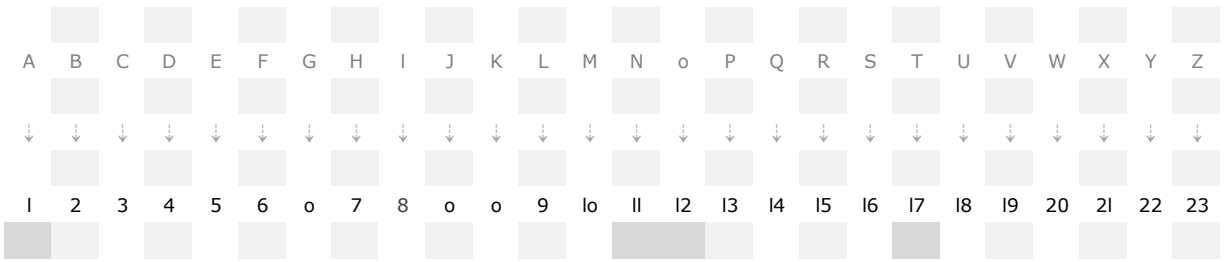

A	B	C	D	E	F	G	H	I	J	K	L	M	N	o	P	Q	R	S	T	U	V	W	X	Y	Z
↓	↓	↓	↓	↓	↓	↓	↓	↓	↓	↓	↓	↓	↓	↓	↓	↓	↓	↓	↓	↓	↓	↓	↓	↓	↓
1	2	3	4	5	6	o	7	8	o	o	9	1o	11	12	13	14	15	16	17	18	19	20	21	22	23

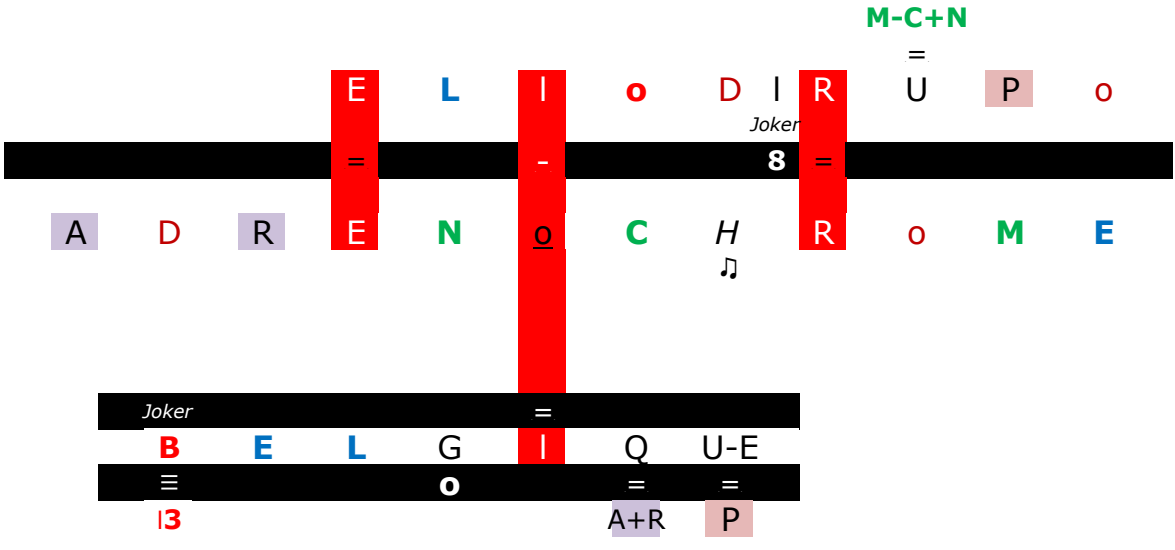

A	B	C	D	E	F	G	H	I	J	K	L	M	N	o	P	Q	R	S	T	U	V	W	X	Y	Z
↓	↓	↓	↓	↓	↓	↓	↓	↓	↓	↓	↓	↓	↓	↓	↓	↓	↓	↓	↓	↓	↓	↓	↓	↓	↓
1	2	3	4	5	6	o	7	8	o	o	9	1o	11	12	13	14	15	16	17	18	19	20	21	22	23

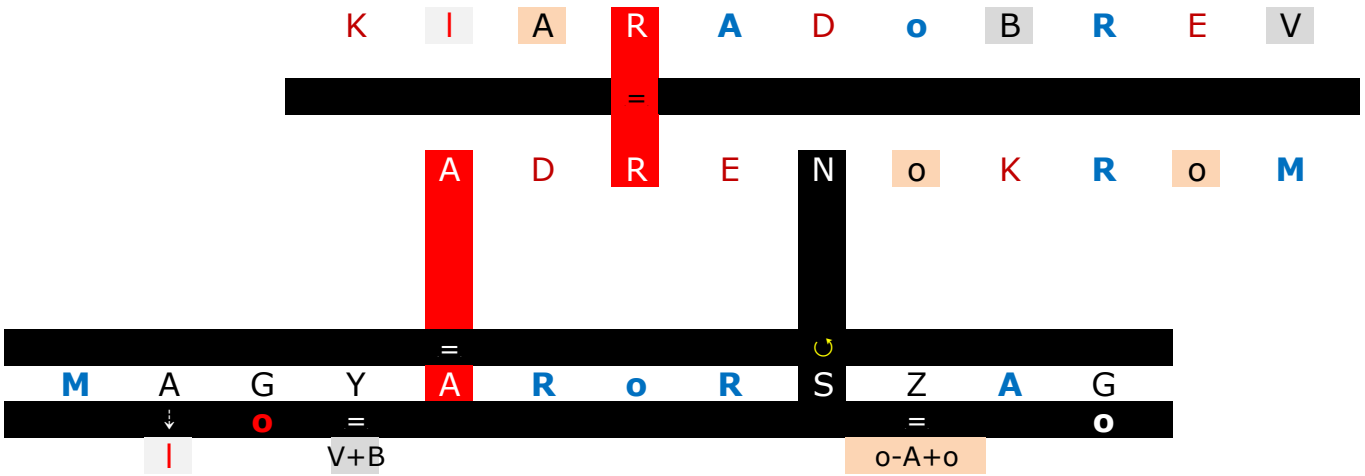

I gira  
 Hungria  
 U/n GIRA N/S



A	B	C	D	E	F	G	H	I	J	K	L	M	N	o	P	Q	R	S	T	U	V	W	X	Y	Z
↓	↓	↓	↓	↓	↓	↓	↓	↓	↓	↓	↓	↓	↓	↓	↓	↓	↓	↓	↓	↓	↓	↓	↓	↓	↓
1	2	3	4	5	6	o	7	8	o	o	9	1o	11	12	13	14	15	16	17	18	19	2o	21	22	23

J o N A S F E R N A N D E Z

---

o =

A D R E N o C R o M o

=  
N-A

Joker =

E S P A N A

13 =

F-R+A-N+Z-C

A	B	C	D	E	F	G	H	I	J	K	L	M	N	o	P	Q	R	S	T	U	V	W	X	Y	Z
↓	↓	↓	↓	↓	↓	↓	↓	↓	↓	↓	↓	↓	↓	↓	↓	↓	↓	↓	↓	↓	↓	↓	↓	↓	↓
1	2	3	4	5	6	o	7	8	o	o	9	1o	11	12	13	14	15	16	17	18	19	2o	21	22	23

N-H =

G A B R I E L A F I R E A

---

o =

A D R E N o C H R o M A

=  
E-A

= = = =

R o M A N I A

= =

R+F+C B-I

A	B	C	D	E	F	G	H	I	J	K	L	M	N	O	P	Q	R	S	T	U	V	W	X	Y	Z
↓	↓	↓	↓	↓	↓	↓	↓	↓	↓	↓	↓	↓	↓	↓	↓	↓	↓	↓	↓	↓	↓	↓	↓	↓	↓
1	2	3	4	5	6	o	7	8	o	o	9	lo	ll	12	13	14	15	16	17	18	19	20	21	22	23

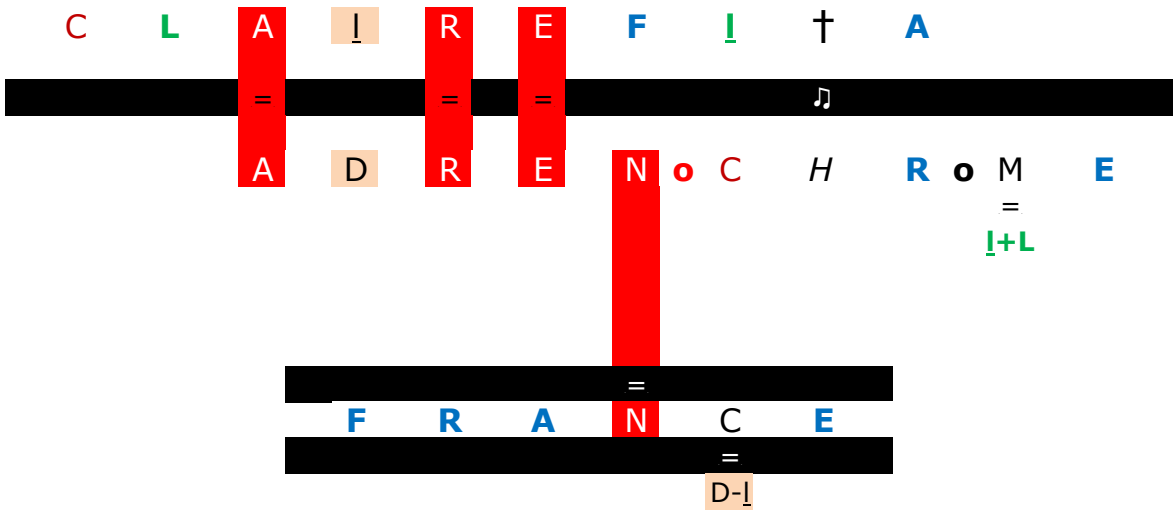

A	B	C	D	E	F	G	H	I	J	K	L	M	N	O	P	Q	R	S	T	U	V	W	X	Y	Z
↓	↓	↓	↓	↓	↓	↓	↓	↓	↓	↓	↓	↓	↓	↓	↓	↓	↓	↓	↓	↓	↓	↓	↓	↓	↓
1	2	3	4	5	6	o	7	8	o	o	9	lo	ll	12	13	14	15	16	17	18	19	20	21	22	23

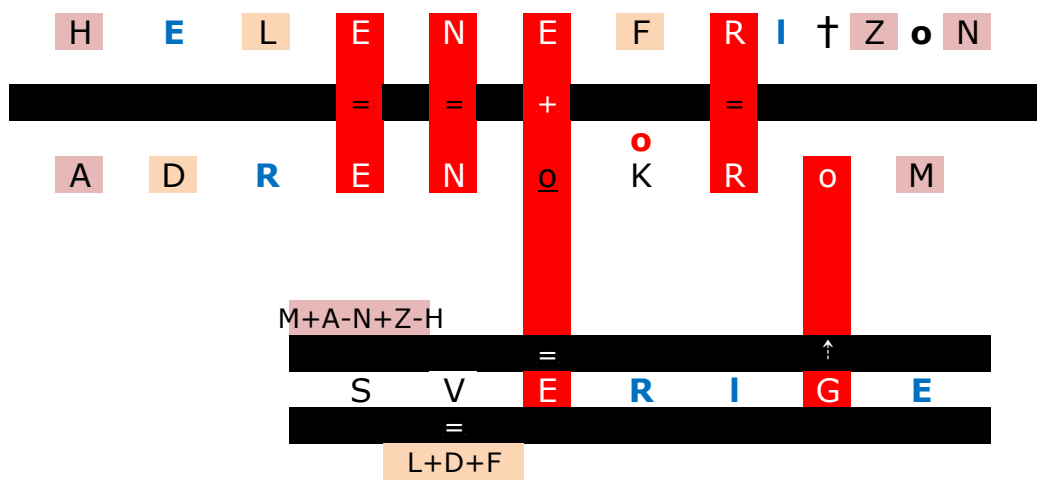

A	B	C	D	E	F	G	H	I	J	K	L	M	N	o	P	Q	R	S	T	U	V	W	X	Y	Z
↓	↓	↓	↓	↓	↓	↓	↓	↓	↓	↓	↓	↓	↓	↓	↓	↓	↓	↓	↓	↓	↓	↓	↓	↓	↓
1	2	3	4	5	6	o	7	8	o	o	9	1o	11	12	13	14	15	16	17	18	19	20	21	22	23

**N** **E** **I** **L** **S** **F** **U** **G** **L** **S** **A** **N** **G**

---

o

**A** **D** **R** **E** **N** **o** **K** **R** **o** **M**

S-U+L+L-S

=

**D** **A** **N** **M** **A** **R** **K**

=

A-F-I+R

A	B	C	D	E	F	G	H	I	J	K	L	M	N	o	P	Q	R	S	T	U	V	W	X	Y	Z
↓	↓	↓	↓	↓	↓	↓	↓	↓	↓	↓	↓	↓	↓	↓	↓	↓	↓	↓	↓	↓	↓	↓	↓	↓	↓
1	2	3	4	5	6	o	7	8	o	o	9	1o	11	12	13	14	15	16	17	18	19	20	21	22	23

**L** **I** **N** **A** **G** **A** **L** **V** **E** **Z**

*Joker*

---

8 = o

**A** **D** **R** **E** **N** **o** **C** **R** **o** **M** **o**

R-R+D+o+L-L

=

**E** **S** **P** **A** **N** **A**

=

Z-V+A C+M

A	B	C	D	E	F	G	H	I	J	K	L	M	N	o	P	Q	R	S	T	U	V	W	X	Y	Z
↓	↓	↓	↓	↓	↓	↓	↓	↓	↓	↓	↓	↓	↓	↓	↓	↓	↓	↓	↓	↓	↓	↓	↓	↓	↓
1	2	3	4	5	6	o	7	8	o	o	9	lo	ll	12	13	14	15	16	17	18	19	20	21	22	23

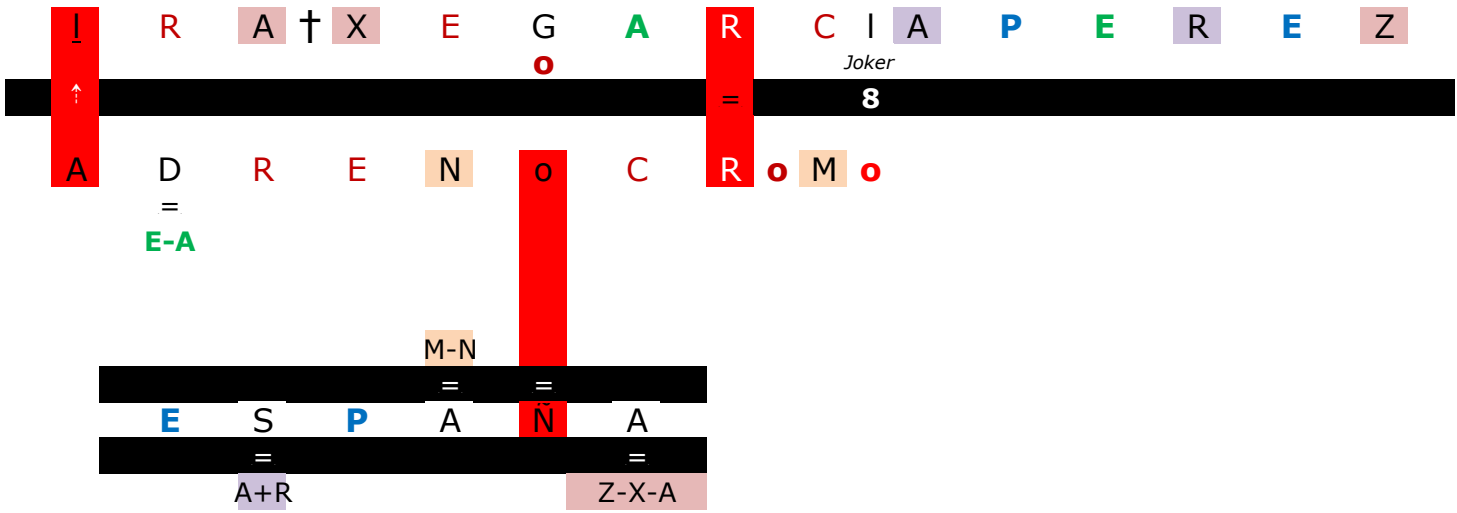

A	B	C	D	E	F	G	H	I	J	K	L	M	N	o	P	Q	R	S	T	U	V	W	X	Y	Z
↓	↓	↓	↓	↓	↓	↓	↓	↓	↓	↓	↓	↓	↓	↓	↓	↓	↓	↓	↓	↓	↓	↓	↓	↓	↓
1	2	3	4	5	6	o	7	8	o	o	9	lo	ll	12	13	14	15	16	17	18	19	20	21	22	23

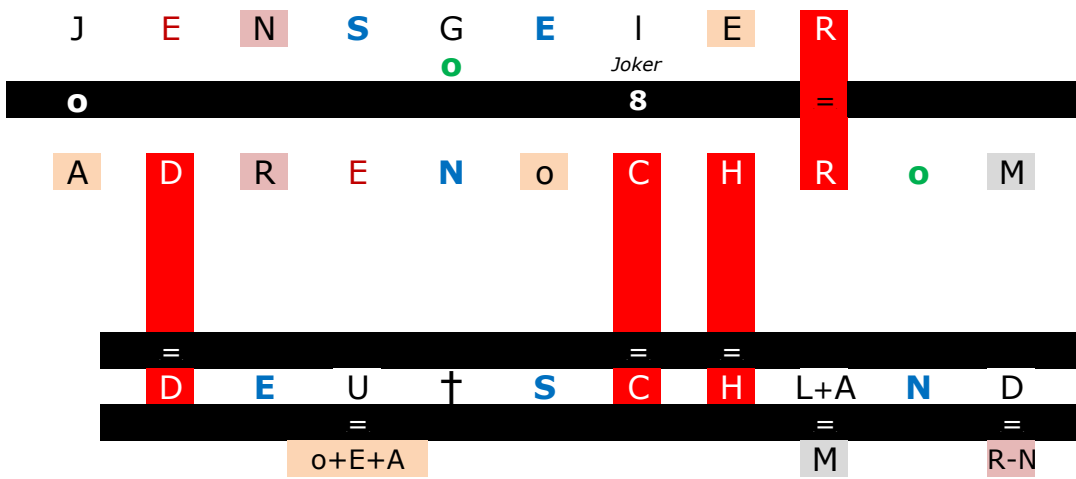

A	B	C	D	E	F	G	H	I	J	K	L	M	N	o	P	Q	R	S	T	U	V	W	X	Y	Z		
↓	↓	↓	↓	↓	↓	↓	↓	↓	↓	↓	↓	↓	↓	↓	↓	↓	↓	↓	↓	↓	↓	↓	↓	↓	↓		
I	2	3	4	5	6	o	7	8	o	o	9	lo	ll	12	13	14	15	16	17	18	19	20	2l	22	23		

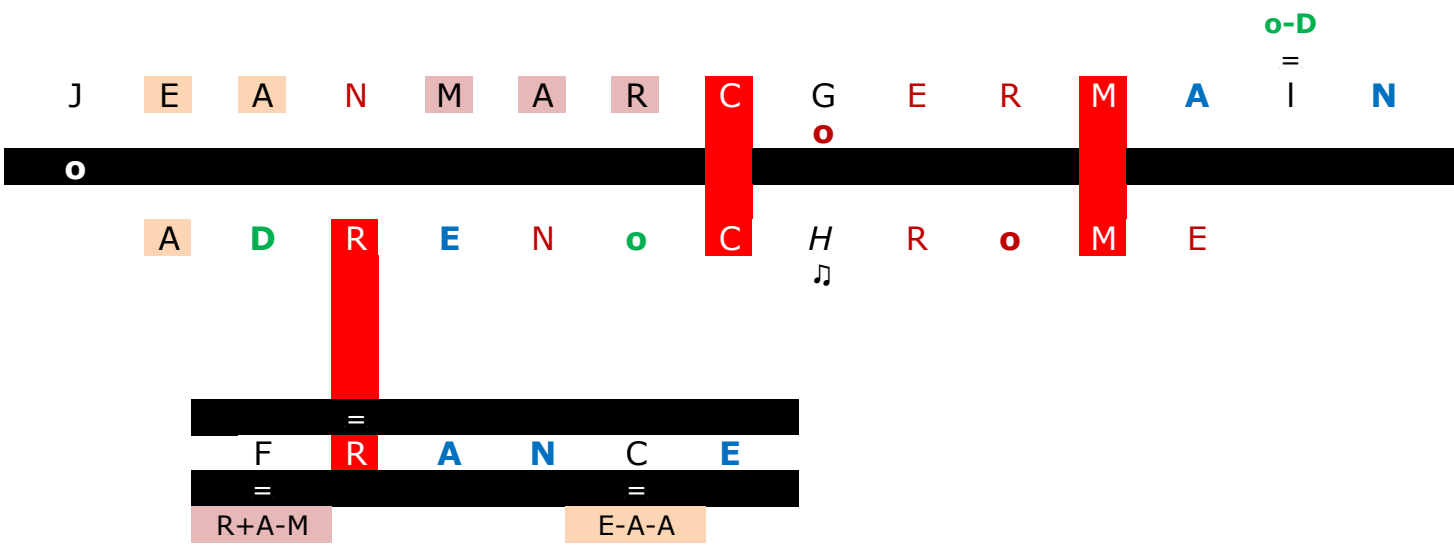

A	B	C	D	E	F	G	H	I	J	K	L	M	N	o	P	Q	R	S	T	U	V	W	X	Y	Z		
↓	↓	↓	↓	↓	↓	↓	↓	↓	↓	↓	↓	↓	↓	↓	↓	↓	↓	↓	↓	↓	↓	↓	↓	↓	↓		
I	2	3	4	5	6	o	7	8	o	o	9	lo	ll	12	13	14	15	16	17	18	19	20	2l	22	23		

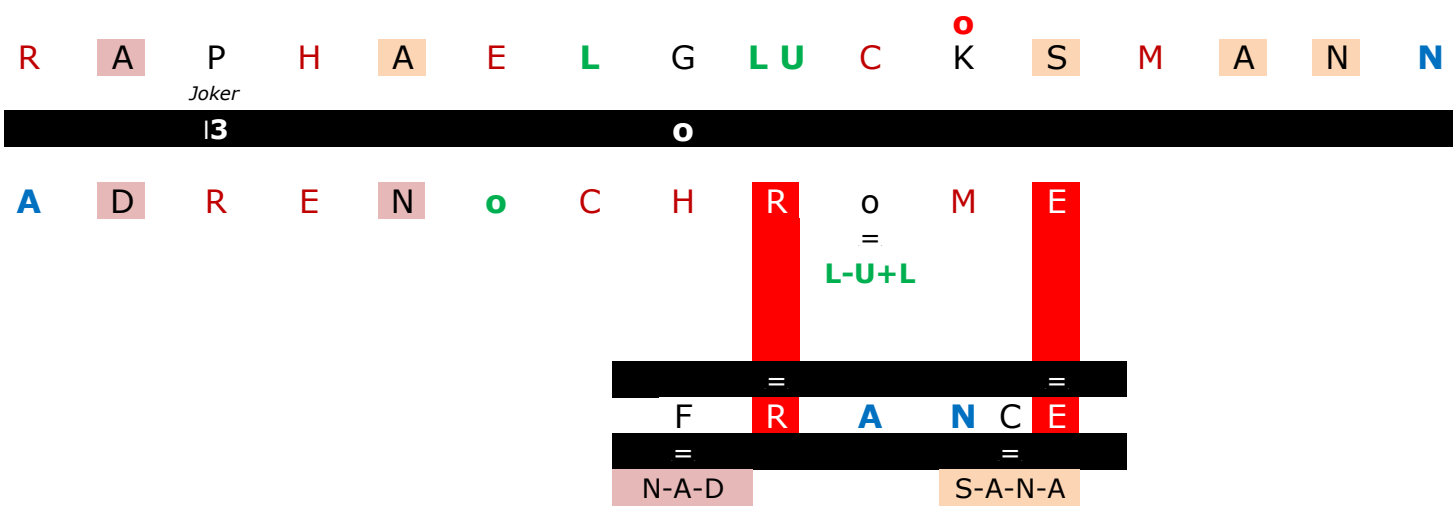

A	B	C	D	E	F	G	H	I	J	K	L	M	N	o	P	Q	R	S	T	U	V	W	X	Y	Z
↓	↓	↓	↓	↓	↓	↓	↓	↓	↓	↓	↓	↓	↓	↓	↓	↓	↓	↓	↓	↓	↓	↓	↓	↓	↓
1	2	3	4	5	6	o	7	8	o	o	9	lo	ll	12	13	14	15	16	17	18	19	20	21	22	23

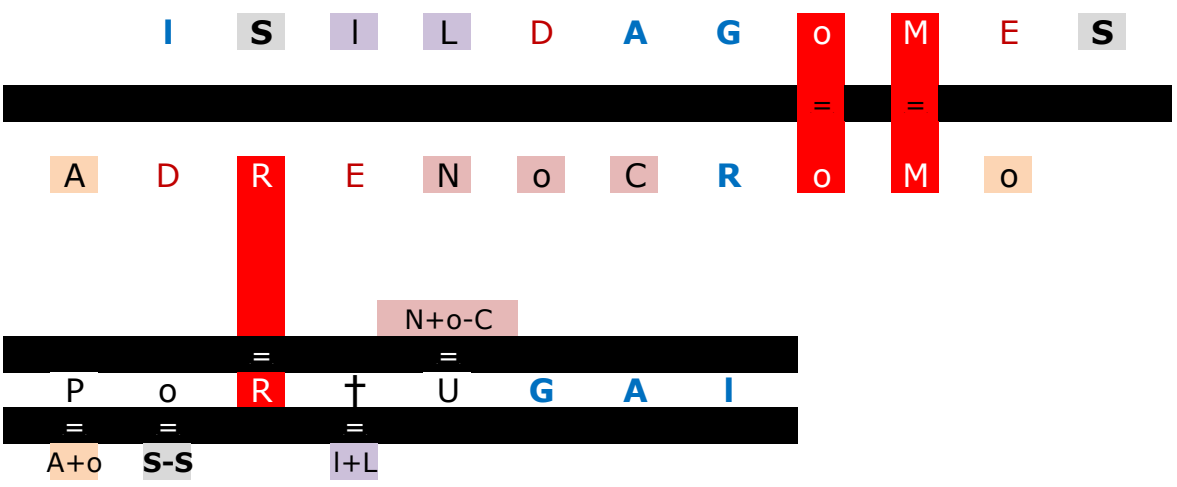

A	B	C	D	E	F	G	H	I	J	K	L	M	N	o	P	Q	R	S	T	U	V	W	X	Y	Z
↓	↓	↓	↓	↓	↓	↓	↓	↓	↓	↓	↓	↓	↓	↓	↓	↓	↓	↓	↓	↓	↓	↓	↓	↓	↓
1	2	3	4	5	6	o	7	8	o	o	9	lo	ll	12	13	14	15	16	17	18	19	20	21	22	23

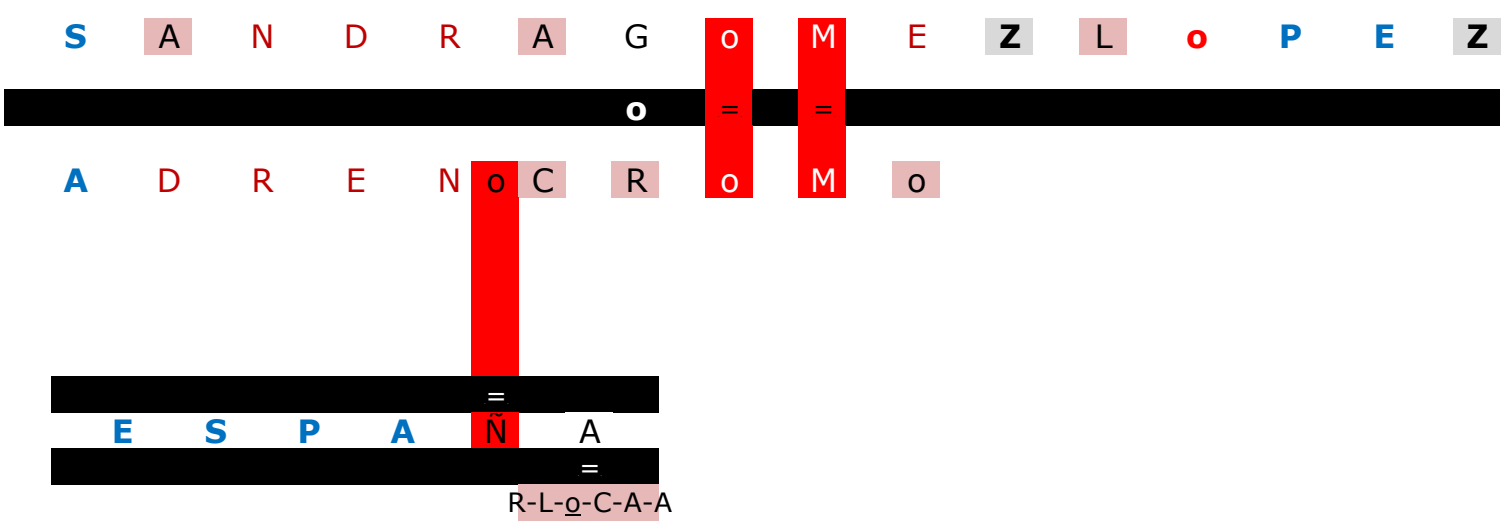

A	B	C	D	E	F	G	H	I	J	K	L	M	N	o	P	Q	R	S	T	U	V	W	X	Y	Z
↓	↓	↓	↓	↓	↓	↓	↓	↓	↓	↓	↓	↓	↓	↓	↓	↓	↓	↓	↓	↓	↓	↓	↓	↓	↓
1	2	3	4	5	6	o	7	8	o	o	9	1o	11	12	13	14	15	16	17	18	19	2o	21	22	23

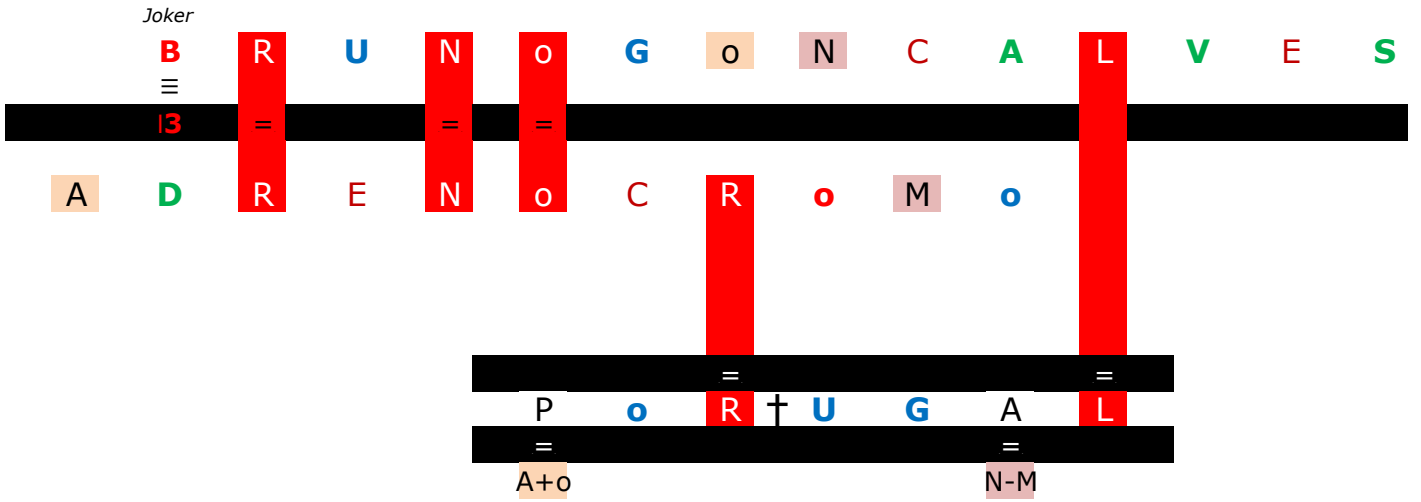

A	B	C	D	E	F	G	H	I	J	K	L	M	N	o	P	Q	R	S	T	U	V	W	X	Y	Z
↓	↓	↓	↓	↓	↓	↓	↓	↓	↓	↓	↓	↓	↓	↓	↓	↓	↓	↓	↓	↓	↓	↓	↓	↓	↓
1	2	3	4	5	6	o	7	8	o	o	9	1o	11	12	13	14	15	16	17	18	19	2o	21	22	23

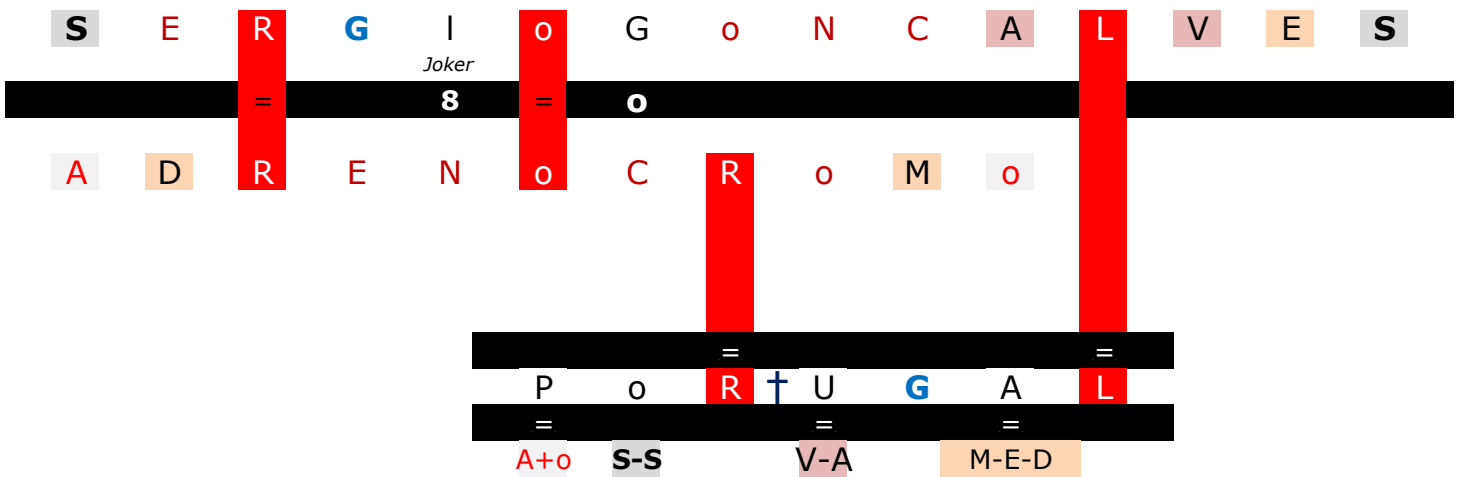

A	B	C	D	E	F	G	H	I	J	K	L	M	N	o	P	Q	R	S	T	U	V	W	X	Y	Z
↓	↓	↓	↓	↓	↓	↓	↓	↓	↓	↓	↓	↓	↓	↓	↓	↓	↓	↓	↓	↓	↓	↓	↓	↓	↓
I	2	3	4	5	6	o	7	8	o	o	9	lo	ll	12	13	14	15	16	17	18	19	20	2l	22	23

**N** **I** **C** **o** **L** **A****S** **G** **o** **N** **Z** **A** **L** **E** **Z** **C****A** **S****A** **R** **E** **S**



**A** **D** **R** **E** **N** **o** **C** **R** **o** **M** **o**

=  
**Z-L+S-S+N-A-Z+L**

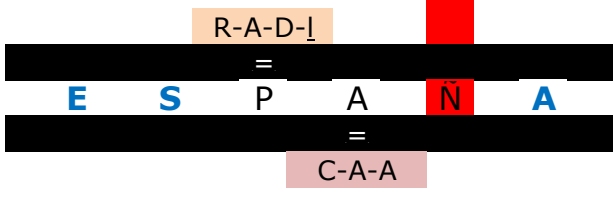

A	B	C	D	E	F	G	H	I	J	K	L	M	N	o	P	Q	R	S	T	U	V	W	X	Y	Z
↓	↓	↓	↓	↓	↓	↓	↓	↓	↓	↓	↓	↓	↓	↓	↓	↓	↓	↓	↓	↓	↓	↓	↓	↓	↓
I	2	3	4	5	6	o	7	8	o	o	9	lo	ll	12	13	14	15	16	17	18	19	20	2l	22	23

**G** **I** **o** **R** **G** **I** **o** **G** **o** **R** **I**  
**o** **o** **o** **o** **o** **o** **o** **o** **o** **o** **o**  
=  
=  
=  
=  
*Joker*  
**8**

**A** **D** **R** **E** **N** **o** **C** **R** **o** **M** **o**

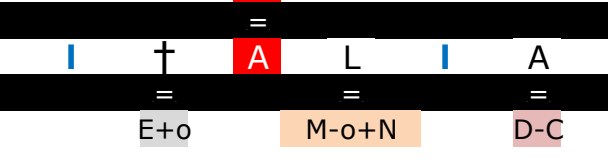



A	B	C	D	E	F	G	H	I	J	K	L	M	N	O	P	Q	R	S	T	U	V	W	X	Y	Z
↓	↓	↓	↓	↓	↓	↓	↓	↓	↓	↓	↓	↓	↓	↓	↓	↓	↓	↓	↓	↓	↓	↓	↓	↓	↓
1	2	3	4	5	6	o	7	8	o	o	9	lo	ll	12	13	14	15	16	17	18	19	20	21	22	23

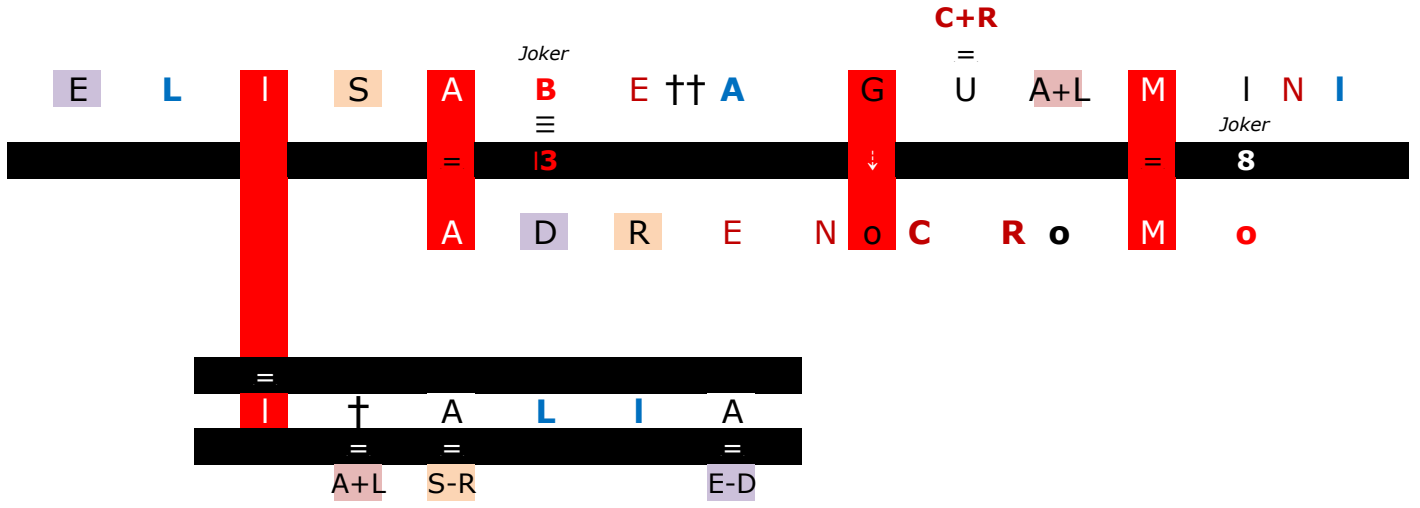

A	B	C	D	E	F	G	H	I	J	K	L	M	N	O	P	Q	R	S	T	U	V	W	X	Y	Z
↓	↓	↓	↓	↓	↓	↓	↓	↓	↓	↓	↓	↓	↓	↓	↓	↓	↓	↓	↓	↓	↓	↓	↓	↓	↓
1	2	3	4	5	6	o	7	8	o	o	9	lo	ll	12	13	14	15	16	17	18	19	20	21	22	23

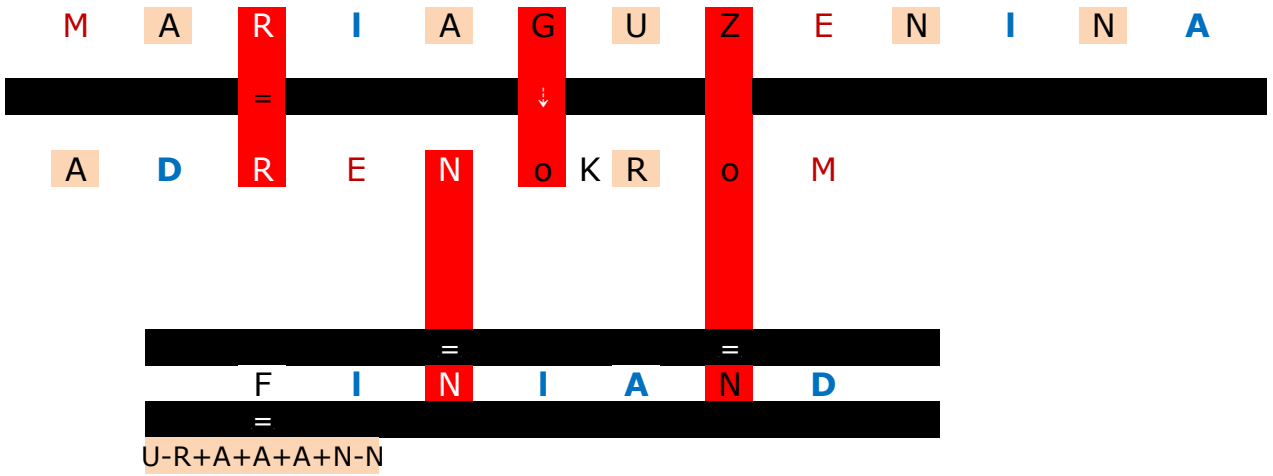

A	B	C	D	E	F	G	H	I	J	K	L	M	N	o	P	Q	R	S	T	U	V	W	X	Y	Z
↓	↓	↓	↓	↓	↓	↓	↓	↓	↓	↓	↓	↓	↓	↓	↓	↓	↓	↓	↓	↓	↓	↓	↓	↓	↓
I	2	3	4	5	6	o	7	8	o	o	9	lo	ll	l2	l3	l4	l5	l6	l7	l8	l9	l0	l1	l2	l3

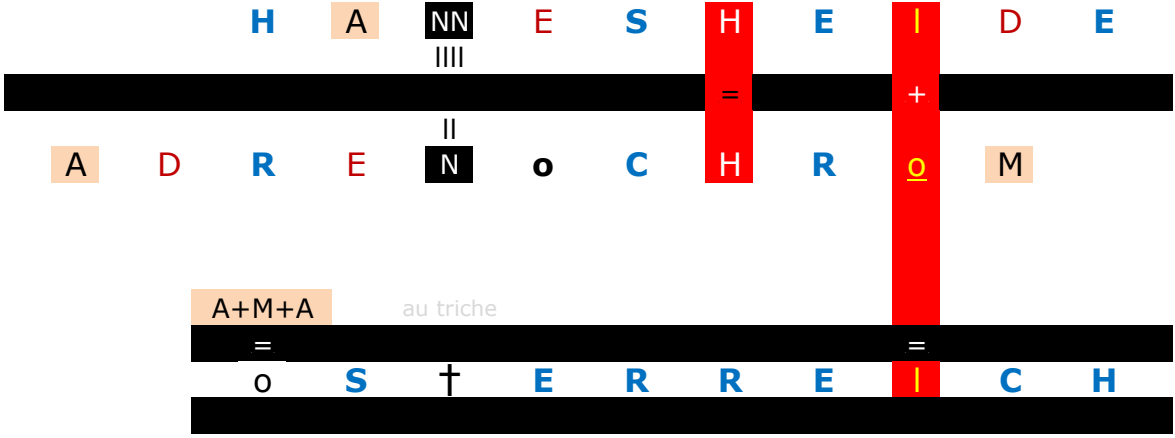

IIIIII- cod 77  
 77-66=IIN + I+I+I+I+I+I=17T  
 66 annes  
 dec 63 hex 3f- 36

A	B	C	D	E	F	G	H	I	J	K	L	M	N	o	P	Q	R	S	T	U	V	W	X	Y	Z
↓	↓	↓	↓	↓	↓	↓	↓	↓	↓	↓	↓	↓	↓	↓	↓	↓	↓	↓	↓	↓	↓	↓	↓	↓	↓
I	2	3	4	5	6	o	7	8	o	o	9	lo	ll	l2	l3	l4	l5	l6	l7	l8	l9	l0	l1	l2	l3

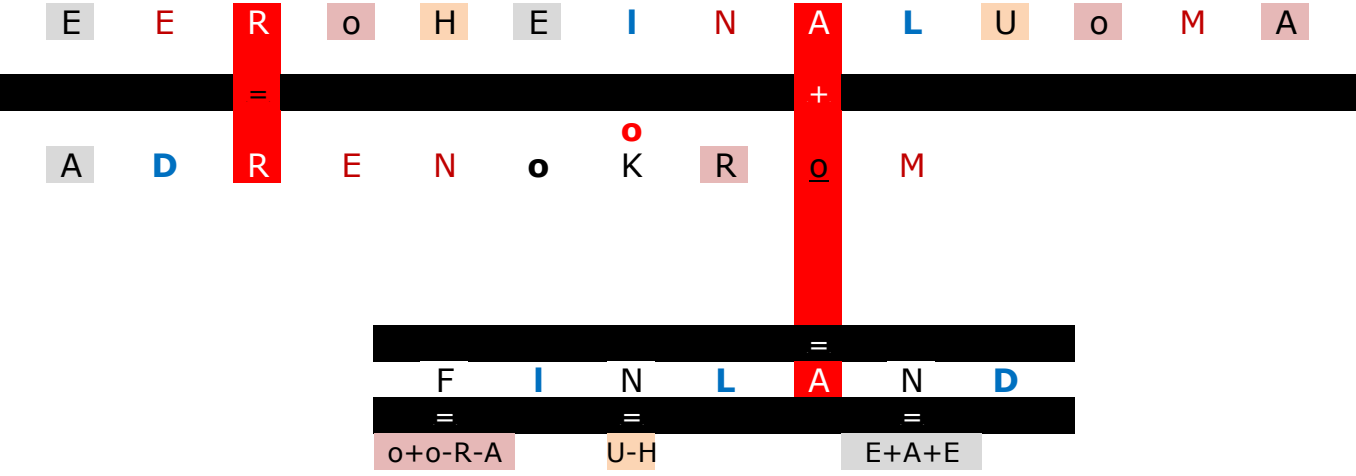

A	B	C	D	E	F	G	H	I	J	K	L	M	N	o	P	Q	R	S	T	U	V	W	X	Y	Z
↓	↓	↓	↓	↓	↓	↓	↓	↓	↓	↓	↓	↓	↓	↓	↓	↓	↓	↓	↓	↓	↓	↓	↓	↓	↓
1	2	3	4	5	6	o	7	8	o	o	9	lo	ll	12	13	14	15	16	17	18	19	20	21	22	23

A L I C I A H o M S G I N E L



A+D R E N o C R o M o  
 =  
 LI-LI

=  
 E S P A N A  
 =  
 R-R+o+l

A	B	C	D	E	F	G	H	I	J	K	L	M	N	o	P	Q	R	S	T	U	V	W	X	Y	Z
↓	↓	↓	↓	↓	↓	↓	↓	↓	↓	↓	↓	↓	↓	↓	↓	↓	↓	↓	↓	↓	↓	↓	↓	↓	↓
1	2	3	4	5	6	o	7	8	o	o	9	lo	ll	12	13	14	15	16	17	18	19	20	21	22	23

E V I N I N C I R



A+D R E N o K R o M

=  
 S V E R I G E  
 =  
 o-N+o M-C-l-l

A	B	C	D	E	F	G	H	I	J	K	L	M	N	o	P	Q	R	S	T	U	V	W	X	Y	Z
↓	↓	↓	↓	↓	↓	↓	↓	↓	↓	↓	↓	↓	↓	↓	↓	↓	↓	↓	↓	↓	↓	↓	↓	↓	↓
I	2	3	4	5	6	o	7	8	o	o	9	lo	ll	12	13	14	15	16	17	18	19	20	21	22	23

D+C

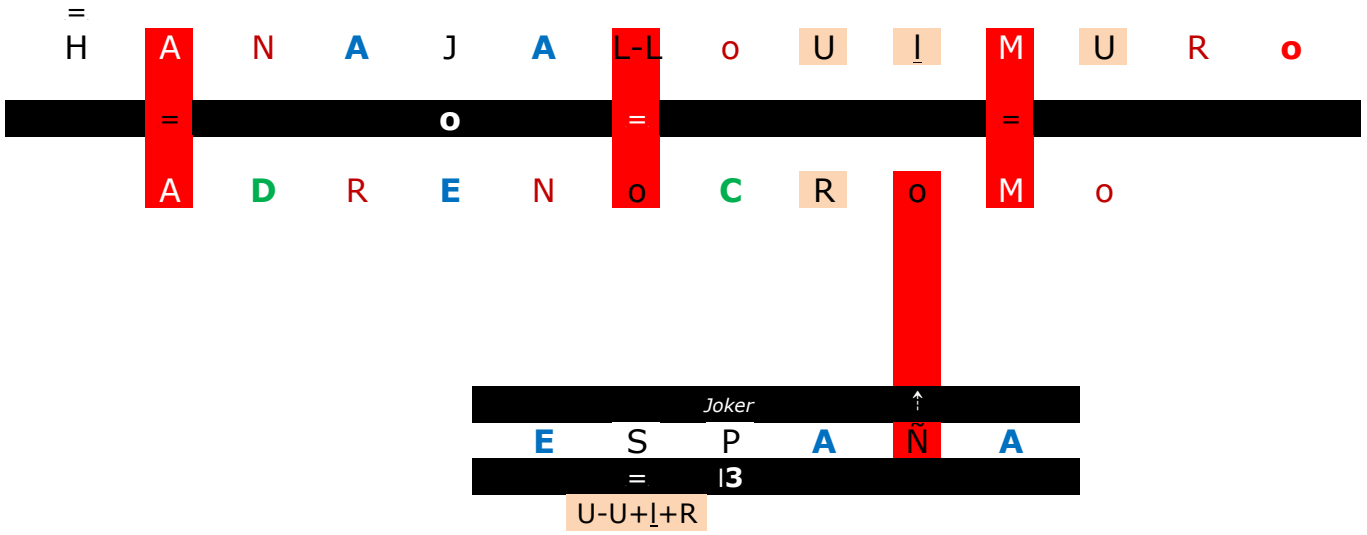

A	B	C	D	E	F	G	H	I	J	K	L	M	N	o	P	Q	R	S	T	U	V	W	X	Y	Z
↓	↓	↓	↓	↓	↓	↓	↓	↓	↓	↓	↓	↓	↓	↓	↓	↓	↓	↓	↓	↓	↓	↓	↓	↓	↓
I	2	3	4	5	6	o	7	8	o	o	9	lo	ll	12	13	14	15	16	17	18	19	20	21	22	23

E-D

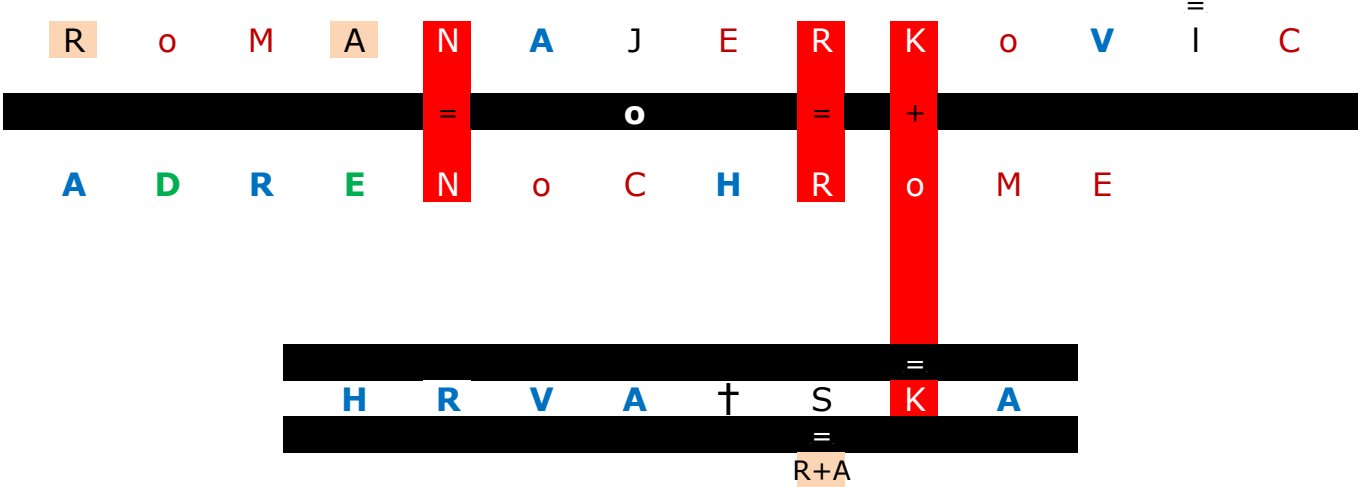



A	B	C	D	E	F	G	H	I	J	K	L	M	N	o	P	Q	R	S	T	U	V	W	X	Y	Z
↓	↓	↓	↓	↓	↓	↓	↓	↓	↓	↓	↓	↓	↓	↓	↓	↓	↓	↓	↓	↓	↓	↓	↓	↓	↓
1	2	3	4	5	6	o	7	8	o	o	9	lo	ll	12	13	14	15	16	17	18	19	20	21	22	23

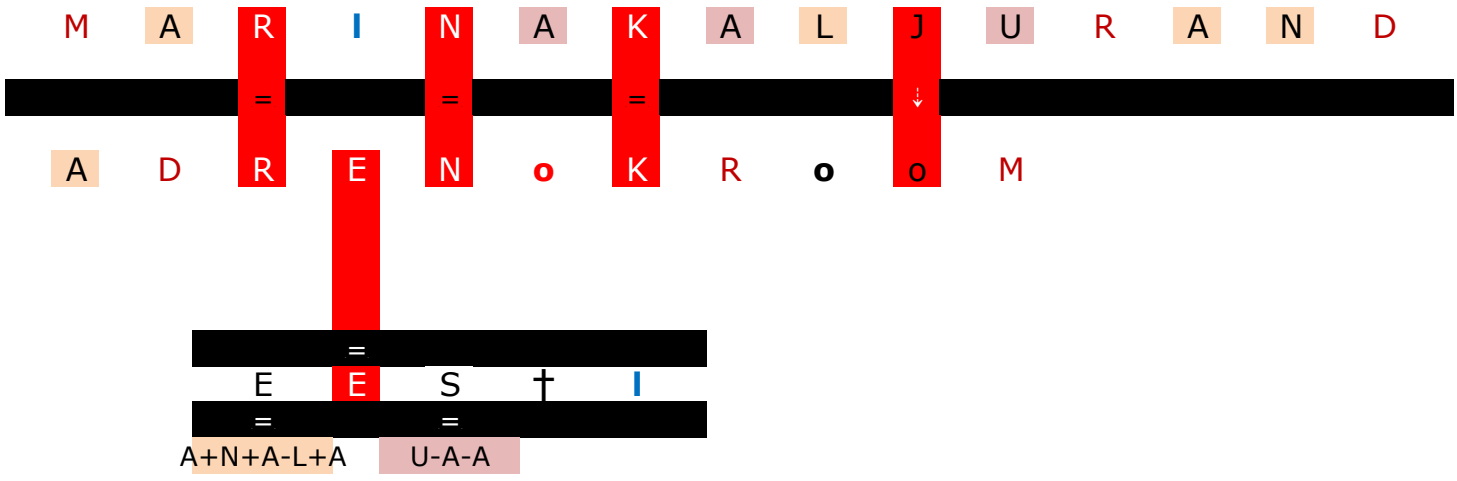

A	B	C	D	E	F	G	H	I	J	K	L	M	N	o	P	Q	R	S	T	U	V	W	X	Y	Z
↓	↓	↓	↓	↓	↓	↓	↓	↓	↓	↓	↓	↓	↓	↓	↓	↓	↓	↓	↓	↓	↓	↓	↓	↓	↓
1	2	3	4	5	6	o	7	8	o	o	9	lo	ll	12	13	14	15	16	17	18	19	20	21	22	23

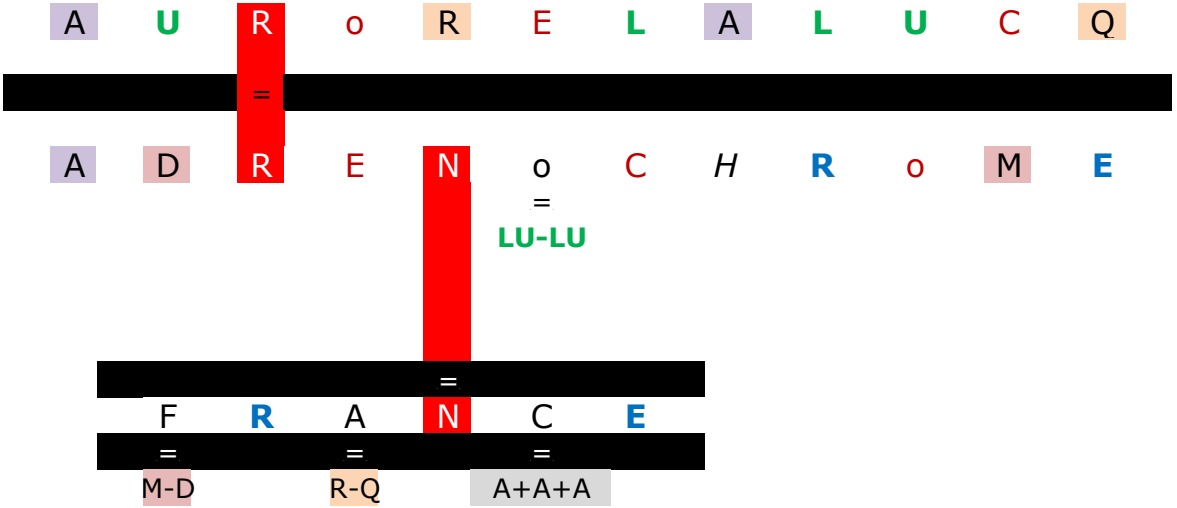





A	B	C	D	E	F	G	H	I	J	K	L	M	N	o	P	Q	R	S	T	U	V	W	X	Y	Z
↓	↓	↓	↓	↓	↓	↓	↓	↓	↓	↓	↓	↓	↓	↓	↓	↓	↓	↓	↓	↓	↓	↓	↓	↓	↓
1	2	3	4	5	6	o	7	8	o	o	9	lo	ll	12	13	14	15	16	17	18	19	20	21	22	23

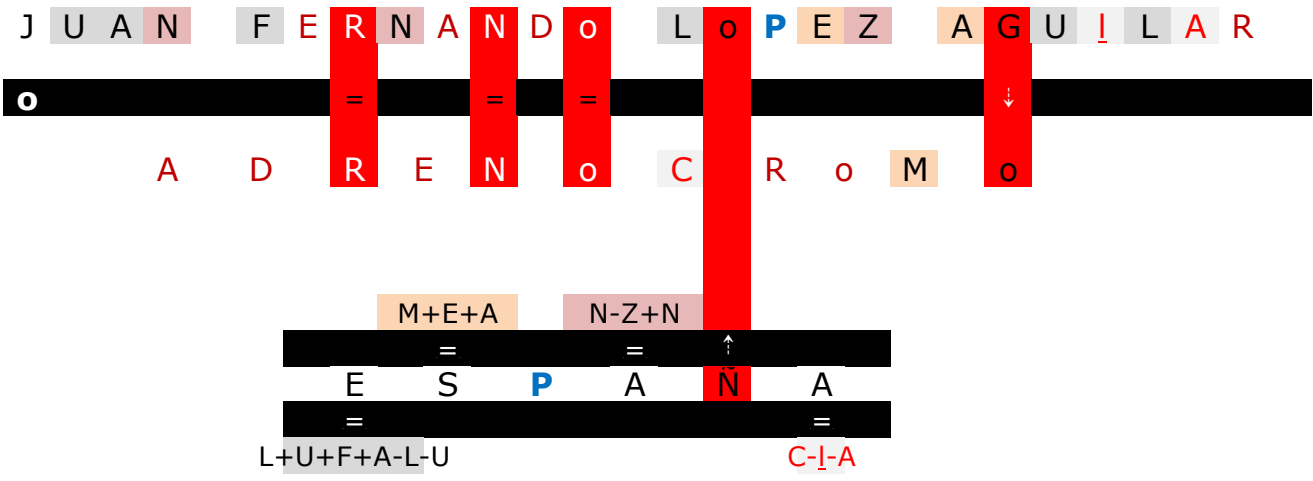

A	B	C	D	E	F	G	H	I	J	K	L	M	N	o	P	Q	R	S	T	U	V	W	X	Y	Z
↓	↓	↓	↓	↓	↓	↓	↓	↓	↓	↓	↓	↓	↓	↓	↓	↓	↓	↓	↓	↓	↓	↓	↓	↓	↓
1	2	3	4	5	6	o	7	8	o	o	9	lo	ll	12	13	14	15	16	17	18	19	20	21	22	23

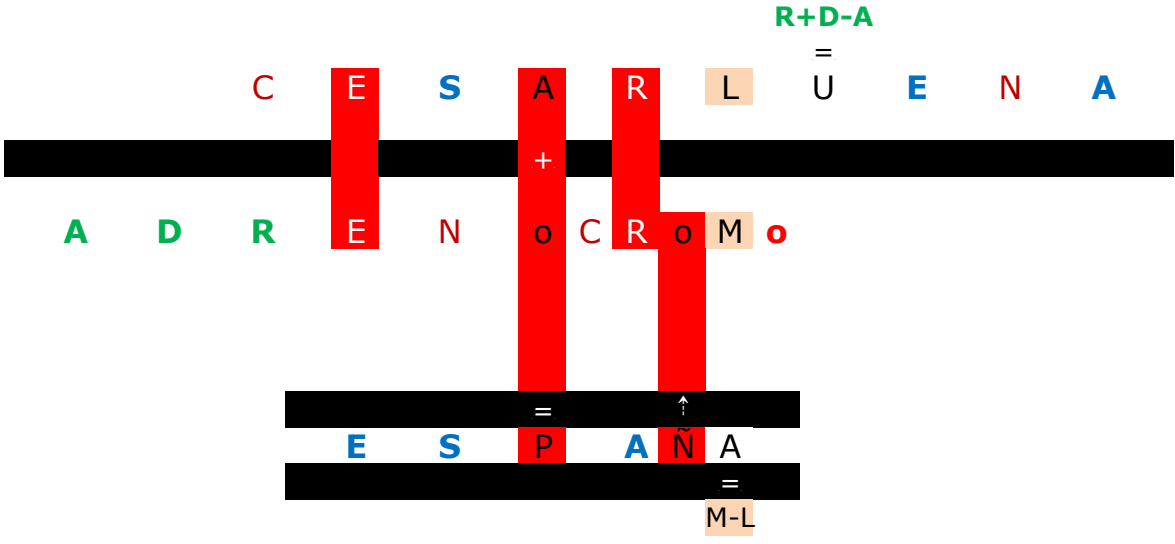

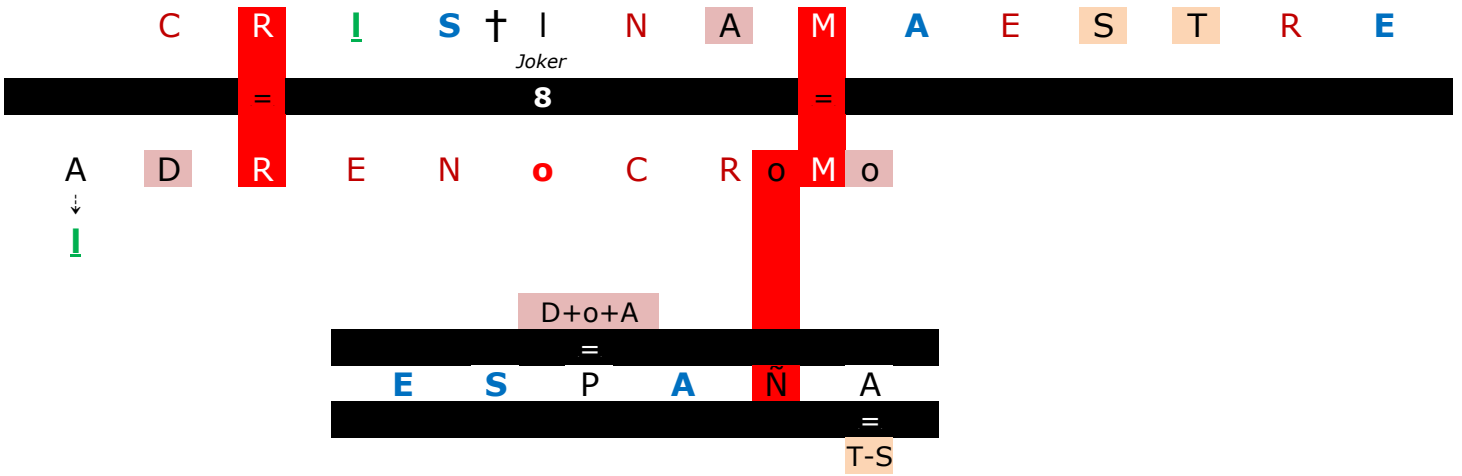
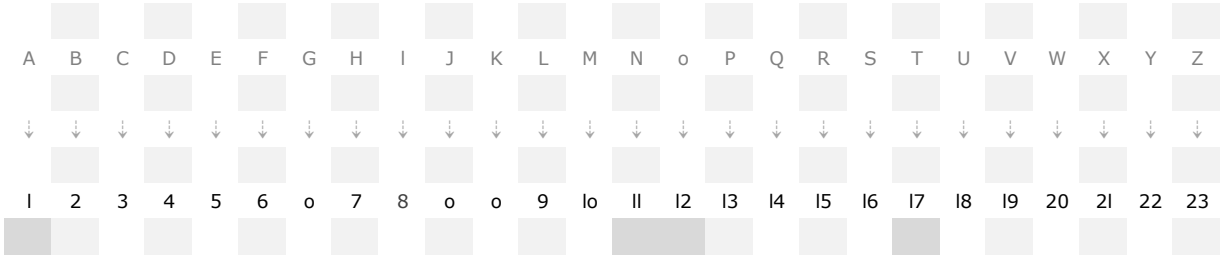
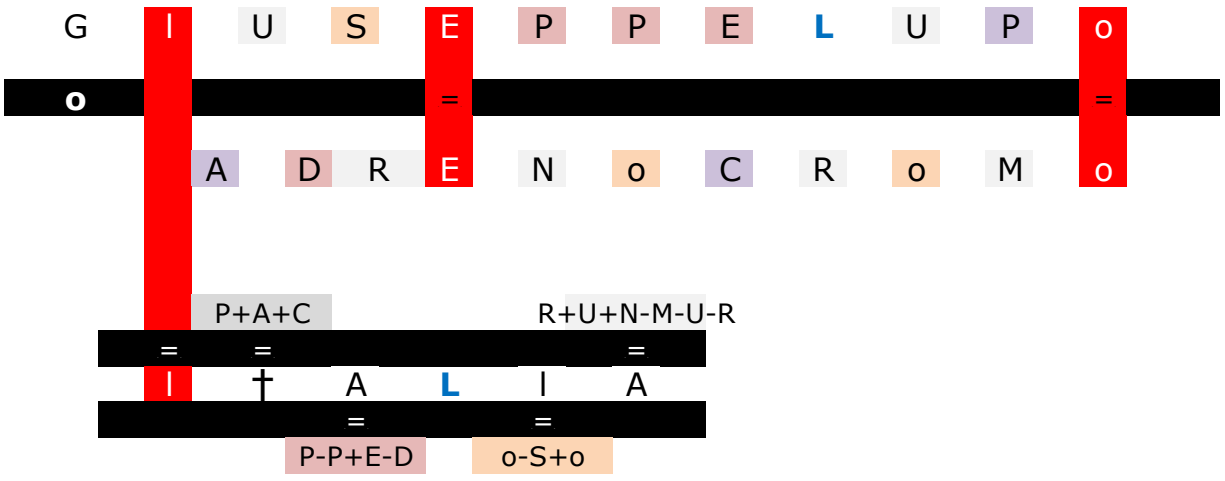
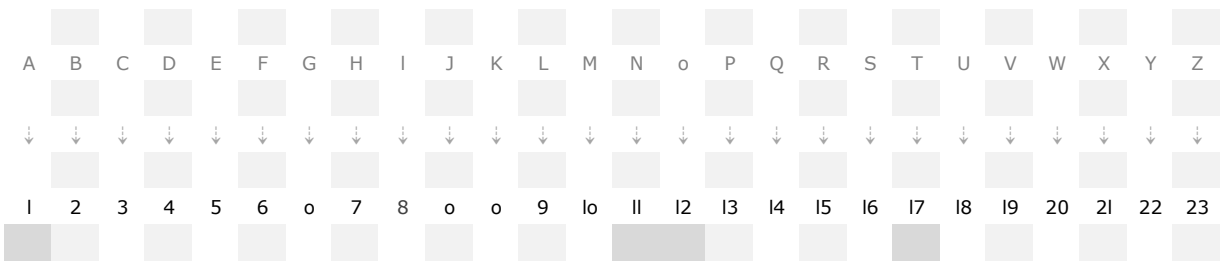

A	B	C	D	E	F	G	H	I	J	K	L	M	N	o	P	Q	R	S	T	U	V	W	X	Y	Z
↓	↓	↓	↓	↓	↓	↓	↓	↓	↓	↓	↓	↓	↓	↓	↓	↓	↓	↓	↓	↓	↓	↓	↓	↓	↓
1	2	3	4	5	6	o	7	8	o	o	9	lo	11	12	13	14	15	16	17	18	19	20	21	22	23

M A R I T M A I J

---

A D R E N o C H R o o M

C+I

---

N E D E R L+A N D S

---

H-A-A o-l M T-A

A	B	C	D	E	F	G	H	I	J	K	L	M	N	o	P	Q	R	S	T	U	V	W	X	Y	Z
↓	↓	↓	↓	↓	↓	↓	↓	↓	↓	↓	↓	↓	↓	↓	↓	↓	↓	↓	↓	↓	↓	↓	↓	↓	↓
1	2	3	4	5	6	o	7	8	o	o	9	lo	11	12	13	14	15	16	17	18	19	20	21	22	23

C L A U D I U M A N D A

---

A D R E N o C H R o M

R-E

---

R o M A N I A

---

D-A+L-A

A	B	C	D	E	F	G	H	I	J	K	L	M	N	o	P	Q	R	S	T	U	V	W	X	Y	Z
↓	↓	↓	↓	↓	↓	↓	↓	↓	↓	↓	↓	↓	↓	↓	↓	↓	↓	↓	↓	↓	↓	↓	↓	↓	↓
1	2	3	4	5	6	o	7	8	o	o	9	lo	11	12	13	14	15	16	17	18	19	20	21	22	23

Y A N N I S M A N I A † I S



A D R E N o C H R o M I U M

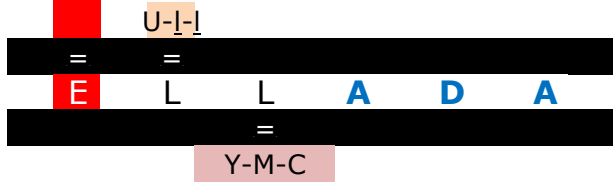

A	B	C	D	E	F	G	H	I	J	K	L	M	N	o	P	Q	R	S	T	U	V	W	X	Y	Z
↓	↓	↓	↓	↓	↓	↓	↓	↓	↓	↓	↓	↓	↓	↓	↓	↓	↓	↓	↓	↓	↓	↓	↓	↓	↓
1	2	3	4	5	6	o	7	8	o	o	9	lo	11	12	13	14	15	16	17	18	19	20	21	22	23

P I ER F R A N C E S C o M A R A N



A D RE N o C R o M o

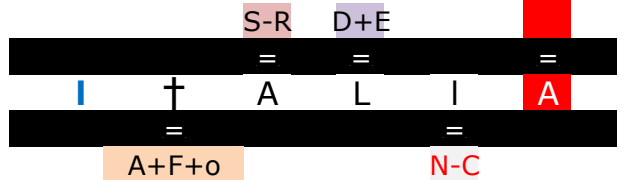

A	B	C	D	E	F	G	H	I	J	K	L	M	N	o	P	Q	R	S	T	U	V	W	X	Y	Z
↓	↓	↓	↓	↓	↓	↓	↓	↓	↓	↓	↓	↓	↓	↓	↓	↓	↓	↓	↓	↓	↓	↓	↓	↓	↓
1	2	3	4	5	6	o	7	8	o	o	9	1o	11	12	13	14	15	16	17	18	19	2o	21	22	23

C o S T A S M AV R I D E S  
 = 8 *Joker*

---

A D R E N o C H R o M A

E+V-A-A

o = =

K Y P R o S

= =

S+H+A-N o+S-T+A

A	B	C	D	E	F	G	H	I	J	K	L	M	N	o	P	Q	R	S	T	U	V	W	X	Y	Z
↓	↓	↓	↓	↓	↓	↓	↓	↓	↓	↓	↓	↓	↓	↓	↓	↓	↓	↓	↓	↓	↓	↓	↓	↓	↓
1	2	3	4	5	6	o	7	8	o	o	9	1o	11	12	13	14	15	16	17	18	19	2o	21	22	23

N o R A M E B A R E K<sup>o</sup>

---

A D R E N o C H R o M E

= =

F R A N C E

= =

E+A o-B-A-H-A

A	B	C	D	E	F	G	H	I	J	K	L	M	N	o	P	Q	R	S	T	U	V	W	X	Y	Z
↓	↓	↓	↓	↓	↓	↓	↓	↓	↓	↓	↓	↓	↓	↓	↓	↓	↓	↓	↓	↓	↓	↓	↓	↓	↓
I	2	3	4	5	6	o	7	8	o	o	9	lo	ll	l2	l3	l4	l5	l6	l7	l8	l9	l0	l1	l2	l3

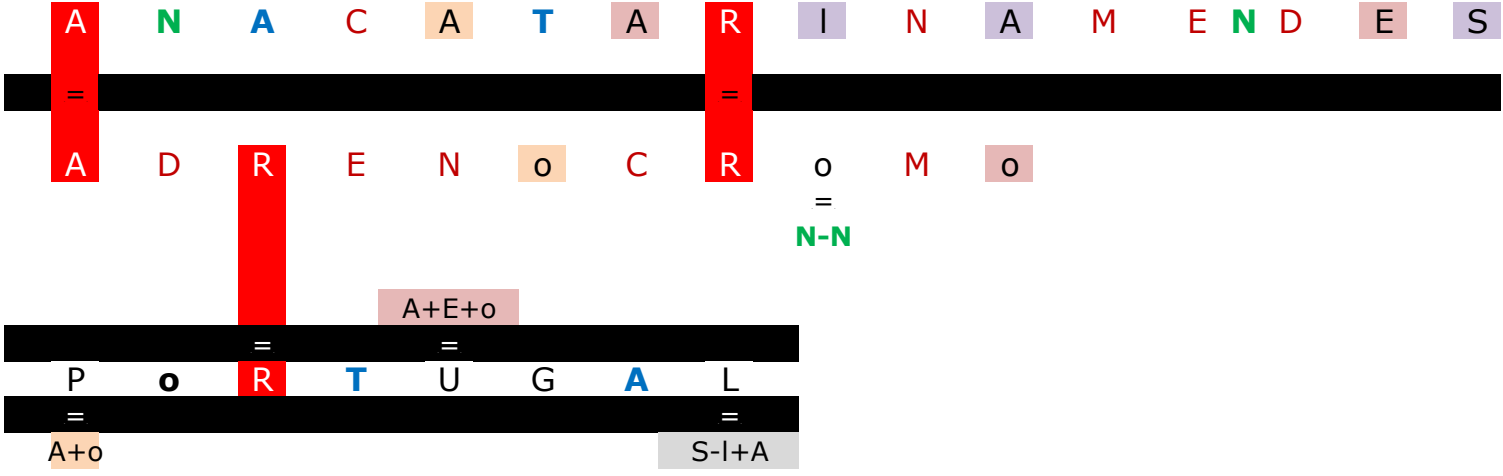

A	B	C	D	E	F	G	H	I	J	K	L	M	N	o	P	Q	R	S	T	U	V	W	X	Y	Z
↓	↓	↓	↓	↓	↓	↓	↓	↓	↓	↓	↓	↓	↓	↓	↓	↓	↓	↓	↓	↓	↓	↓	↓	↓	↓
I	2	3	4	5	6	o	7	8	o	o	9	lo	ll	l2	l3	l4	l5	l6	l7	l8	l9	l0	l1	l2	l3

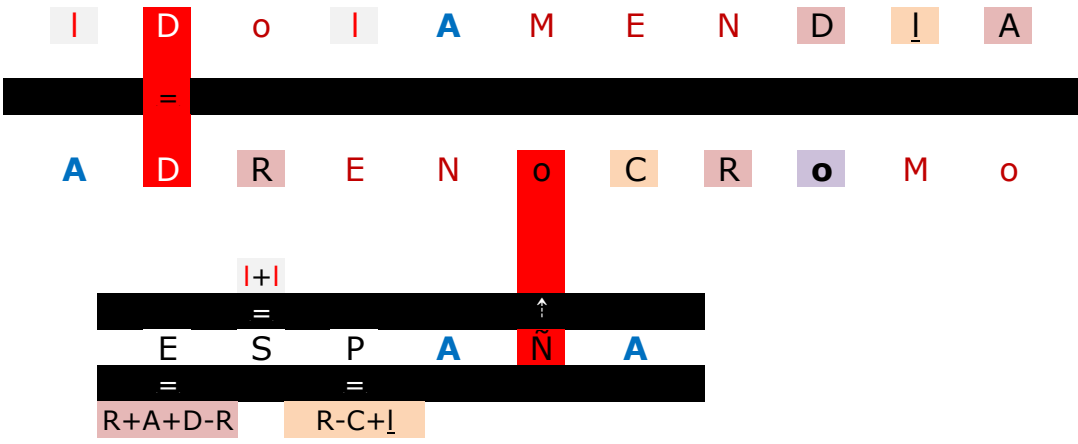

A	B	C	D	E	F	G	H	I	J	K	L	M	N	o	P	Q	R	S	T	U	V	W	X	Y	Z
↓	↓	↓	↓	↓	↓	↓	↓	↓	↓	↓	↓	↓	↓	↓	↓	↓	↓	↓	↓	↓	↓	↓	↓	↓	↓
1	2	3	4	5	6	o	7	8	o	o	9	lo	ll	12	13	14	15	16	17	18	19	20	21	22	23

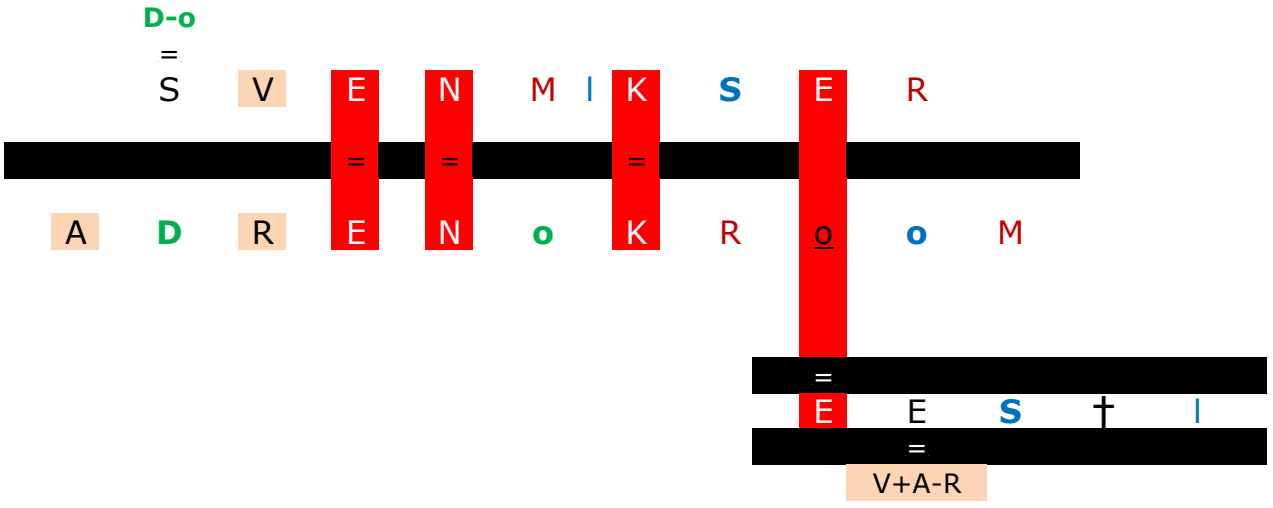

A	B	C	D	E	F	G	H	I	J	K	L	M	N	o	P	Q	R	S	T	U	V	W	X	Y	Z
↓	↓	↓	↓	↓	↓	↓	↓	↓	↓	↓	↓	↓	↓	↓	↓	↓	↓	↓	↓	↓	↓	↓	↓	↓	↓
1	2	3	4	5	6	o	7	8	o	o	9	lo	ll	12	13	14	15	16	17	18	19	20	21	22	23

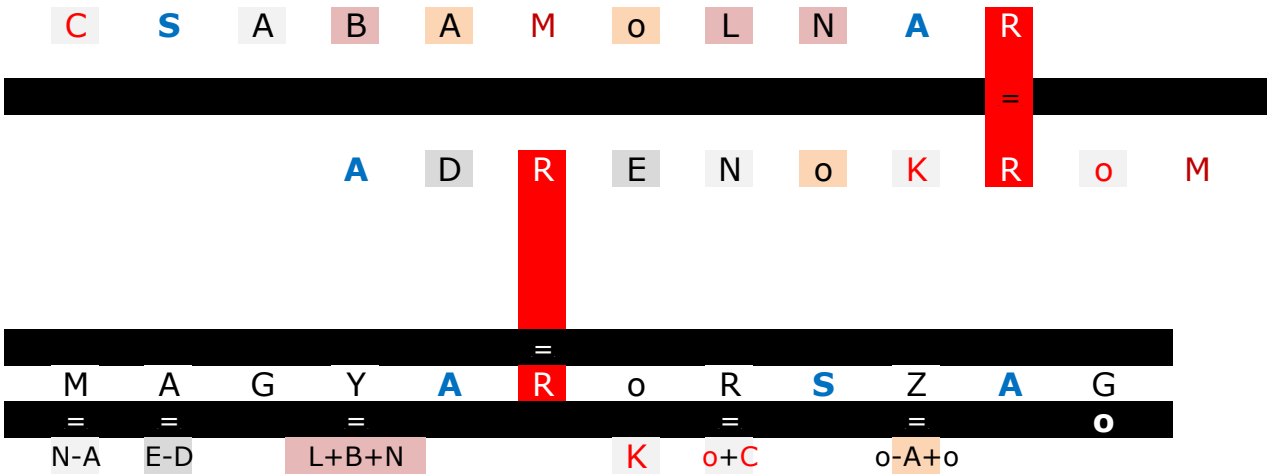

A	B	C	D	E	F	G	H	I	J	K	L	M	N	o	P	Q	R	S	T	U	V	W	X	Y	Z
↓	↓	↓	↓	↓	↓	↓	↓	↓	↓	↓	↓	↓	↓	↓	↓	↓	↓	↓	↓	↓	↓	↓	↓	↓	↓
1	2	3	4	5	6	o	7	8	o	o	9	lo	ll	12	13	14	15	16	17	18	19	20	21	22	23

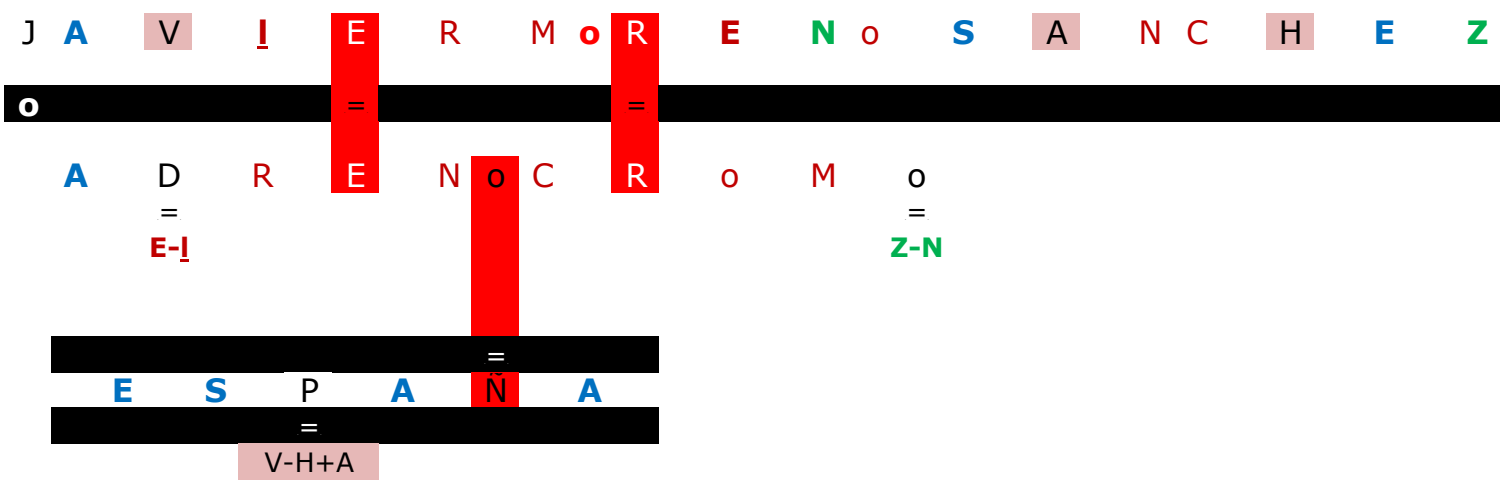

A	B	C	D	E	F	G	H	I	J	K	L	M	N	o	P	Q	R	S	T	U	V	W	X	Y	Z
↓	↓	↓	↓	↓	↓	↓	↓	↓	↓	↓	↓	↓	↓	↓	↓	↓	↓	↓	↓	↓	↓	↓	↓	↓	↓
1	2	3	4	5	6	o	7	8	o	o	9	lo	ll	12	13	14	15	16	17	18	19	20	21	22	23

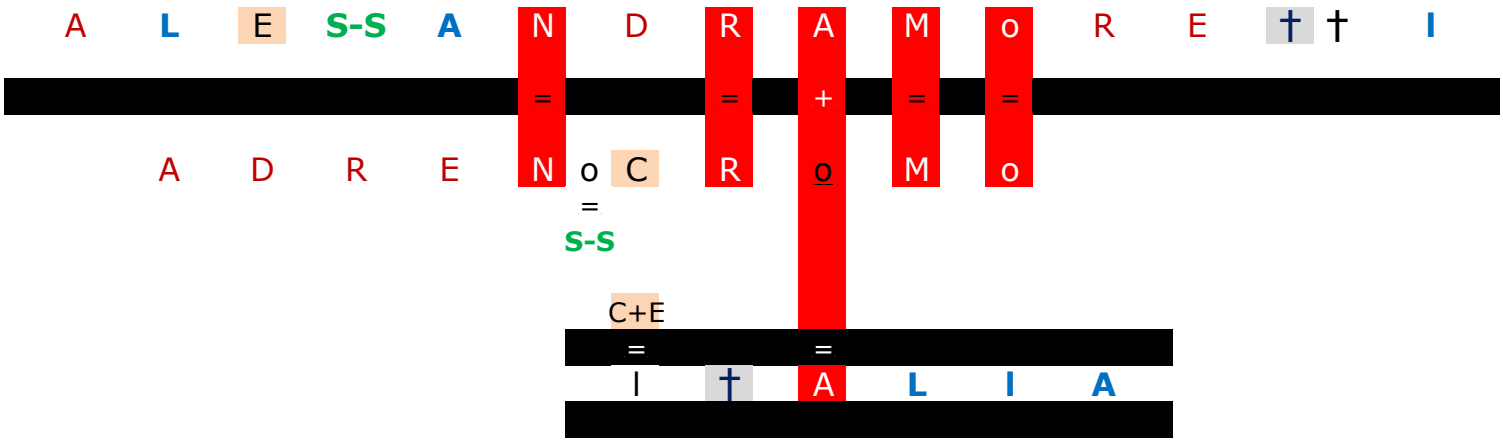

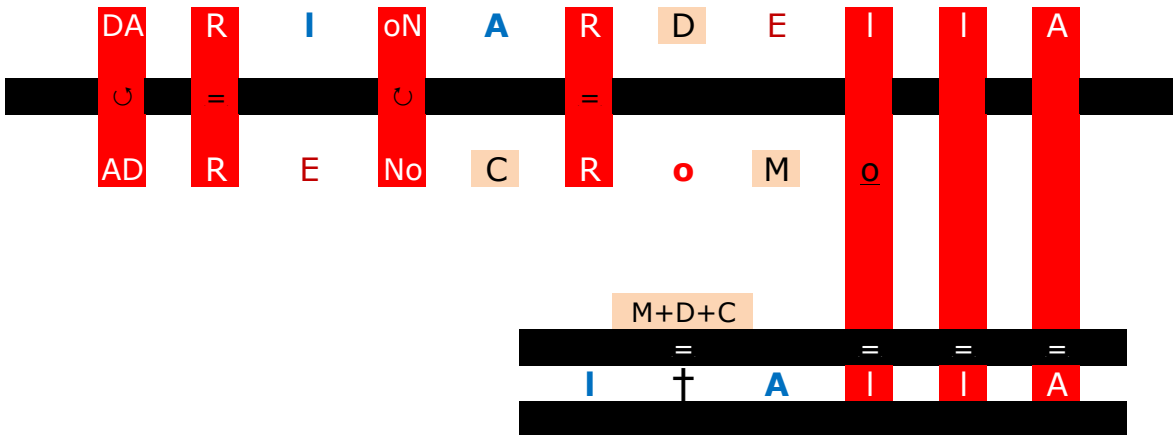
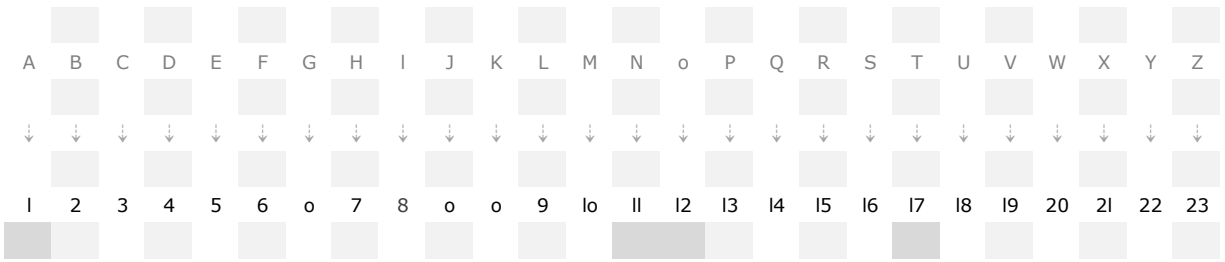
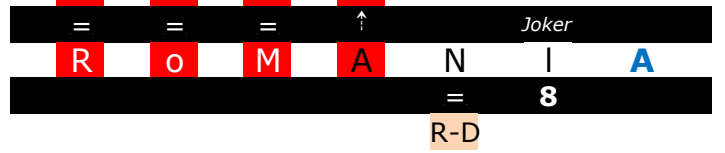
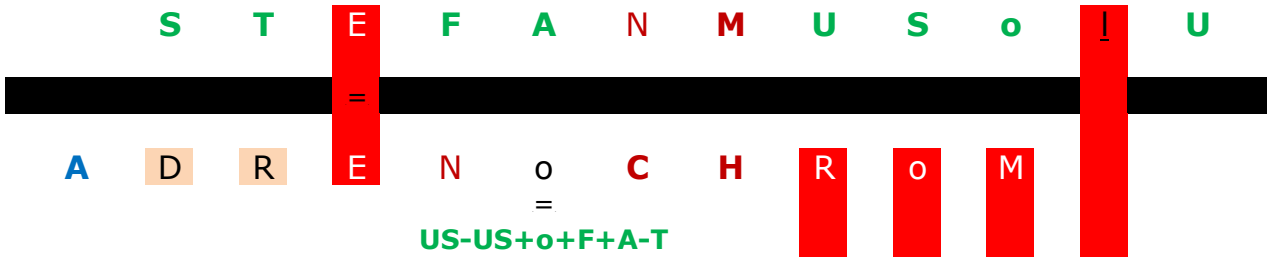
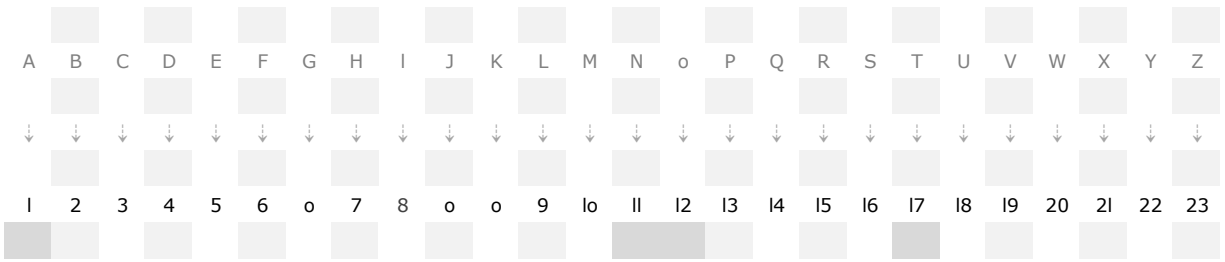

A	B	C	D	E	F	G	H	I	J	K	L	M	N	o	P	Q	R	S	T	U	V	W	X	Y	Z
↓	↓	↓	↓	↓	↓	↓	↓	↓	↓	↓	↓	↓	↓	↓	↓	↓	↓	↓	↓	↓	↓	↓	↓	↓	↓
1	2	3	4	5	6	o	7	8	o	o	9	lo	ll	12	13	14	15	16	17	18	19	20	21	22	23

V I C † o R N E G R E S C U



A D R E N o C H R o M  
 =  
 V-C-S



R o M A+N I A  
 =  
 E+D-o+U

A	B	C	D	E	F	G	H	I	J	K	L	M	N	o	P	Q	R	S	T	U	V	W	X	Y	Z
↓	↓	↓	↓	↓	↓	↓	↓	↓	↓	↓	↓	↓	↓	↓	↓	↓	↓	↓	↓	↓	↓	↓	↓	↓	↓
1	2	3	4	5	6	o	7	8	o	o	9	lo	ll	12	13	14	15	16	17	18	19	20	21	22	23

M A T J A Z N E M E C



A D R E N o C H R o M E

A+T+A-M



S L o V E N I J A



N+E R-D

A	B	C	D	E	F	G	H	I	J	K	L	M	N	o	P	Q	R	S	T	U	V	W	X	Y	Z
↓	↓	↓	↓	↓	↓	↓	↓	↓	↓	↓	↓	↓	↓	↓	↓	↓	↓	↓	↓	↓	↓	↓	↓	↓	↓
1	2	3	4	5	6	o	7	8	o	o	9	lo	ll	12	13	14	15	16	17	18	19	20	21	22	23

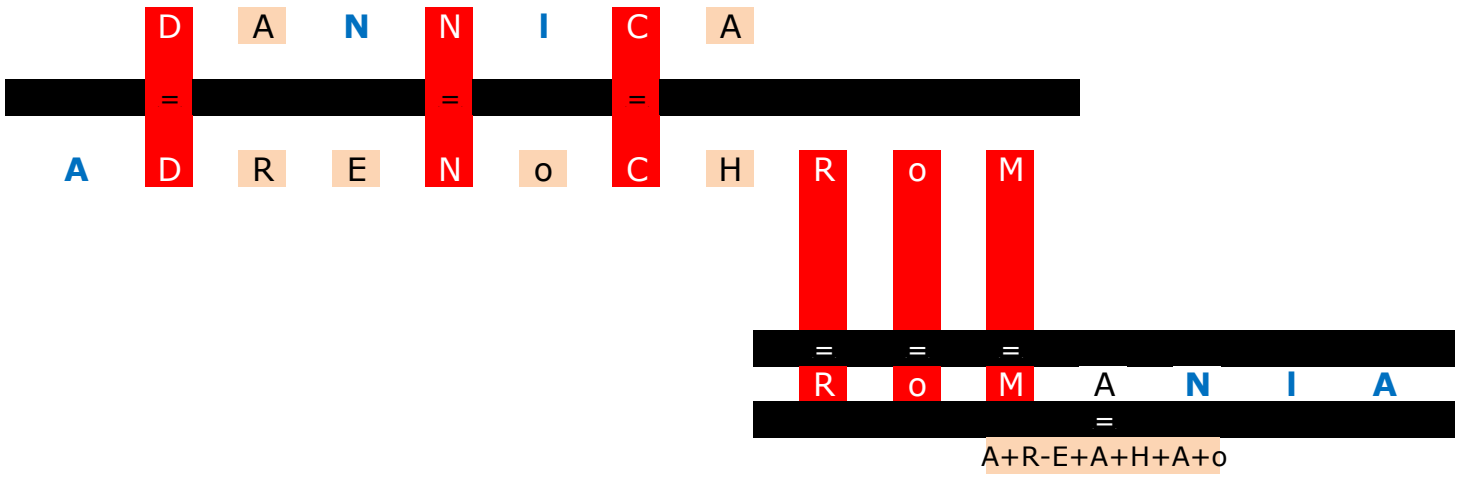

A	B	C	D	E	F	G	H	I	J	K	L	M	N	o	P	Q	R	S	T	U	V	W	X	Y	Z
↓	↓	↓	↓	↓	↓	↓	↓	↓	↓	↓	↓	↓	↓	↓	↓	↓	↓	↓	↓	↓	↓	↓	↓	↓	↓
1	2	3	4	5	6	o	7	8	o	o	9	lo	ll	12	13	14	15	16	17	18	19	20	21	22	23

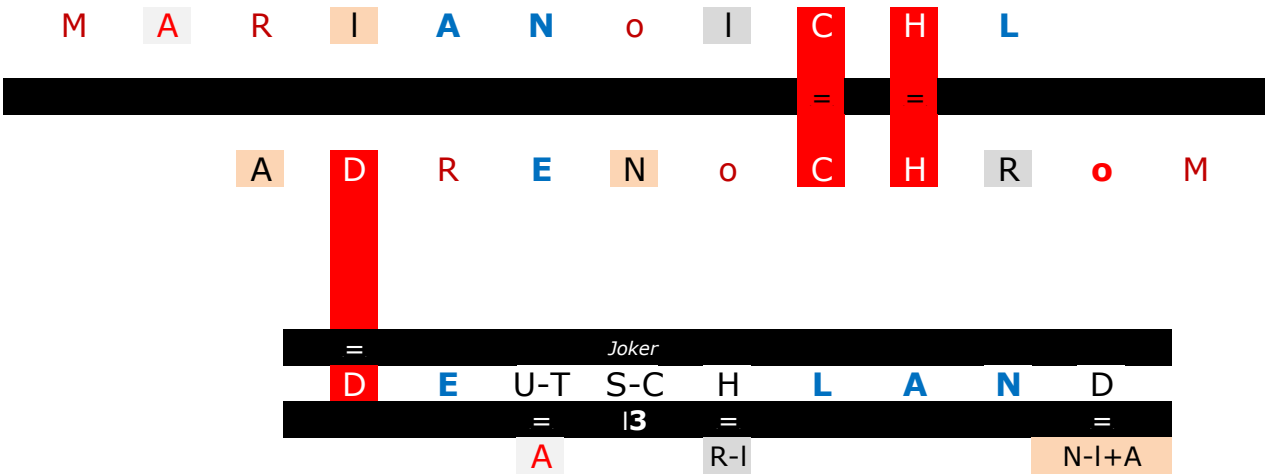

A	B	C	D	E	F	G	H	I	J	K	L	M	N	o	P	Q	R	S	T	U	V	W	X	Y	Z
↓	↓	↓	↓	↓	↓	↓	↓	↓	↓	↓	↓	↓	↓	↓	↓	↓	↓	↓	↓	↓	↓	↓	↓	↓	↓
1	2	3	4	5	6	o	7	8	o	o	9	lo	ll	l2	l3	l4	l5	l6	l7	l8	l9	l0	l1	l2	l3

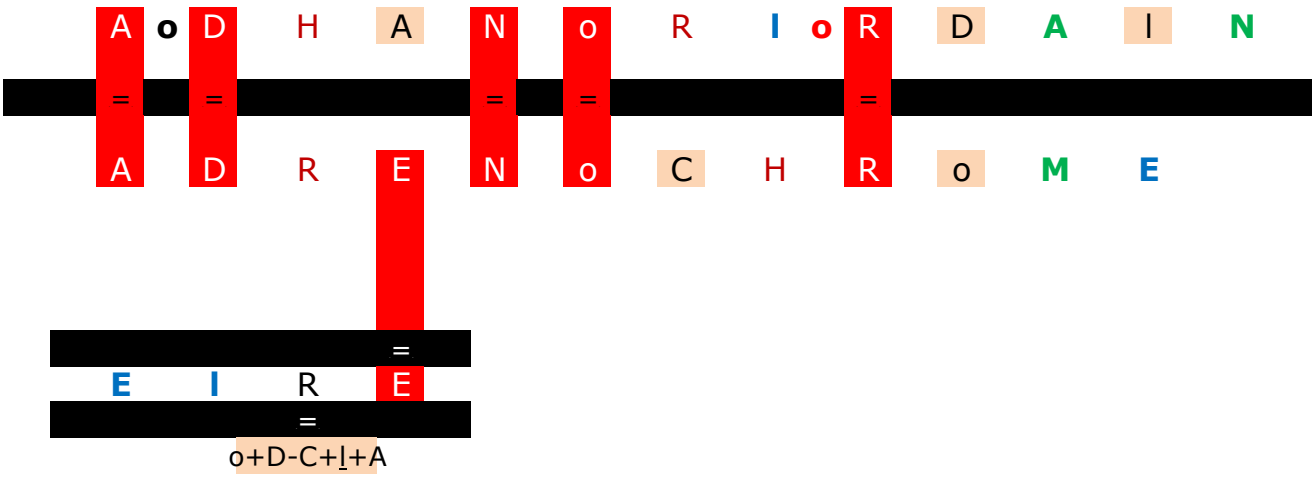

A	B	C	D	E	F	G	H	I	J	K	L	M	N	o	P	Q	R	S	T	U	V	W	X	Y	Z
↓	↓	↓	↓	↓	↓	↓	↓	↓	↓	↓	↓	↓	↓	↓	↓	↓	↓	↓	↓	↓	↓	↓	↓	↓	↓
1	2	3	4	5	6	o	7	8	o	o	9	lo	ll	l2	l3	l4	l5	l6	l7	l8	l9	l0	l1	l2	l3

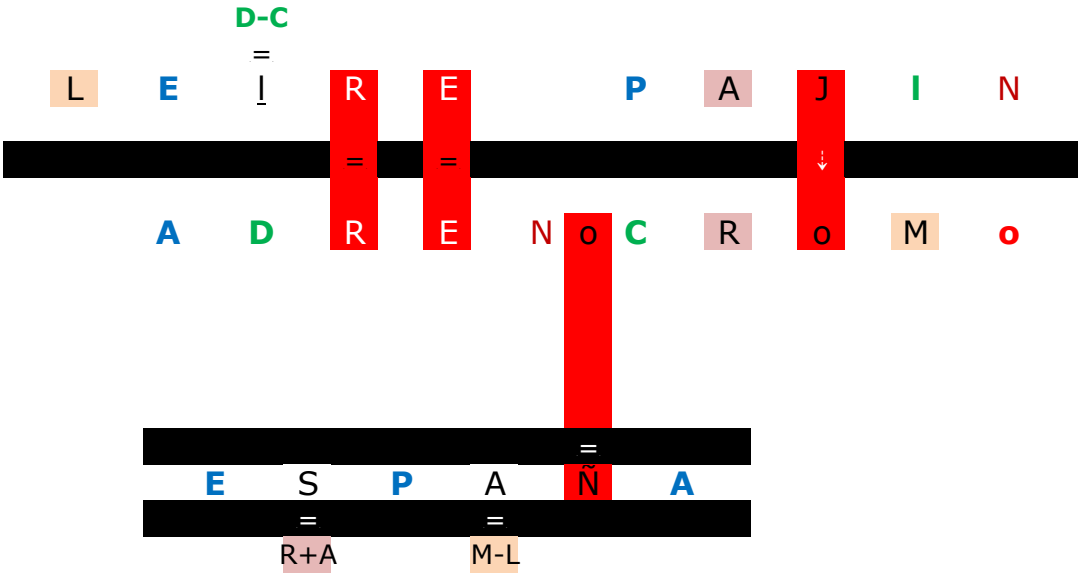

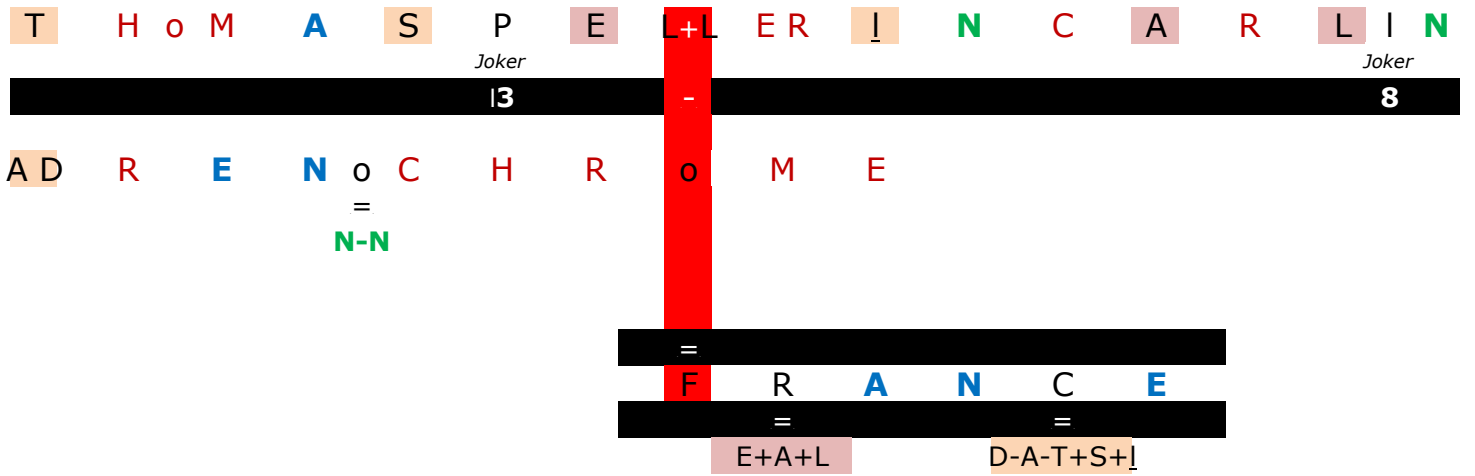
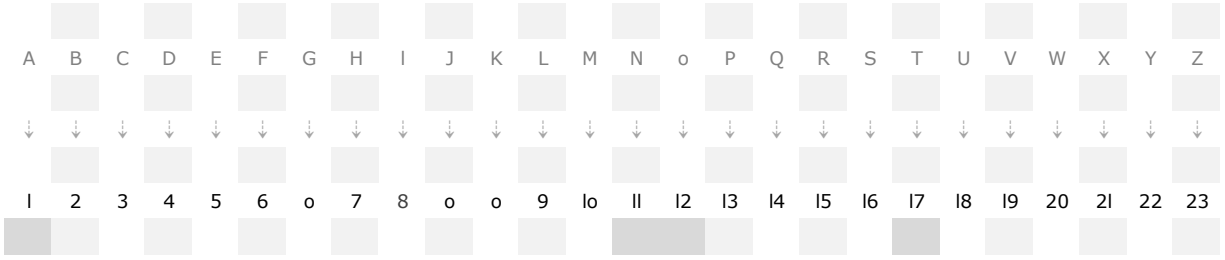
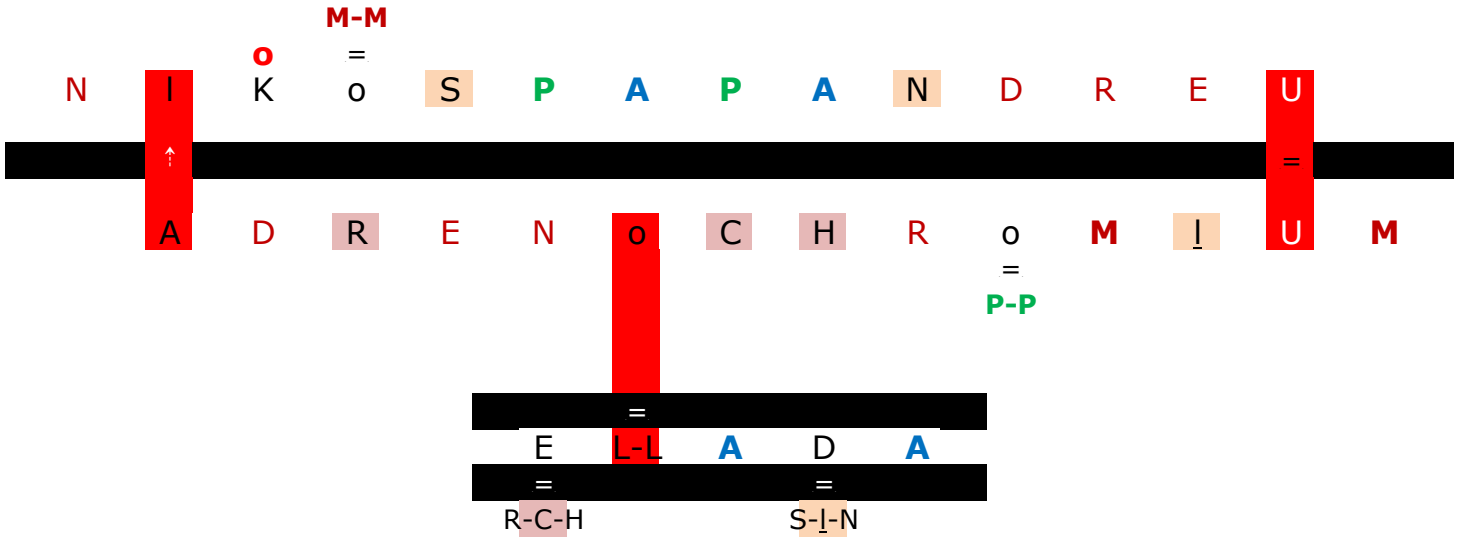
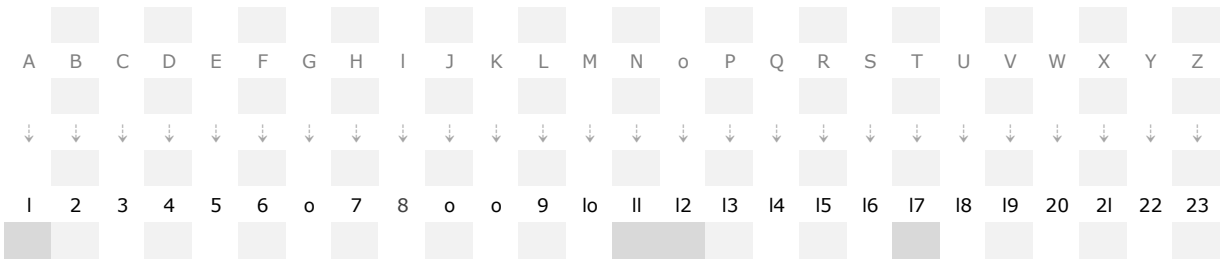

A	B	C	D	E	F	G	H	I	J	K	L	M	N	o	P	Q	R	S	T	U	V	W	X	Y	Z
↓	↓	↓	↓	↓	↓	↓	↓	↓	↓	↓	↓	↓	↓	↓	↓	↓	↓	↓	↓	↓	↓	↓	↓	↓	↓
1	2	3	4	5	6	o	7	8	o	o	9	1o	11	12	13	14	15	16	17	18	19	2o	21	22	23

R-D

T S V E T E L I N A P E N K o V A

=

E

=



A D R E N o K H R o M

TV-TV

B U L G A R E S K I

o-M P+E

A	B	C	D	E	F	G	H	I	J	K	L	M	N	o	P	Q	R	S	T	U	V	W	X	Y	Z
↓	↓	↓	↓	↓	↓	↓	↓	↓	↓	↓	↓	↓	↓	↓	↓	↓	↓	↓	↓	↓	↓	↓	↓	↓	↓
1	2	3	4	5	6	o	7	8	o	o	9	1o	11	12	13	14	15	16	17	18	19	2o	21	22	23

P I N A P I C I E R N o

+

=

-

=

A D R E N o C R o M o

P-P

I A L I A

R-A-D-A

A	B	C	D	E	F	G	H	I	J	K	L	M	N	o	P	Q	R	S	T	U	V	W	X	Y	Z
↓	↓	↓	↓	↓	↓	↓	↓	↓	↓	↓	↓	↓	↓	↓	↓	↓	↓	↓	↓	↓	↓	↓	↓	↓	↓
1	2	3	4	5	6	o	7	8	o	o	9	lo	11	12	13	14	15	16	17	18	19	20	21	22	23

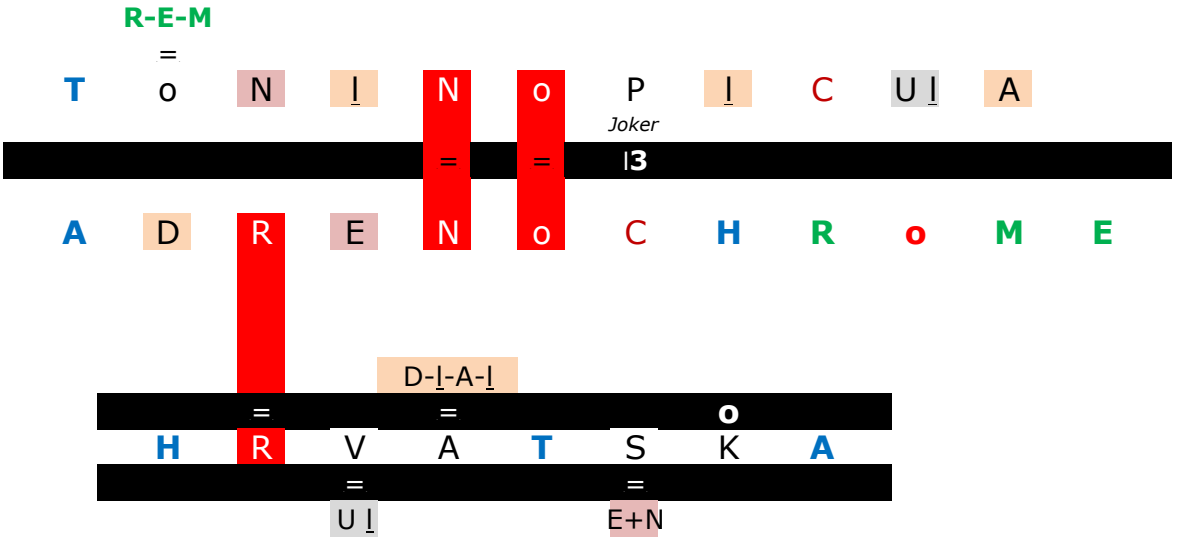

A	B	C	D	E	F	G	H	I	J	K	L	M	N	o	P	Q	R	S	T	U	V	W	X	Y	Z
↓	↓	↓	↓	↓	↓	↓	↓	↓	↓	↓	↓	↓	↓	↓	↓	↓	↓	↓	↓	↓	↓	↓	↓	↓	↓
1	2	3	4	5	6	o	7	8	o	o	9	lo	11	12	13	14	15	16	17	18	19	20	21	22	23

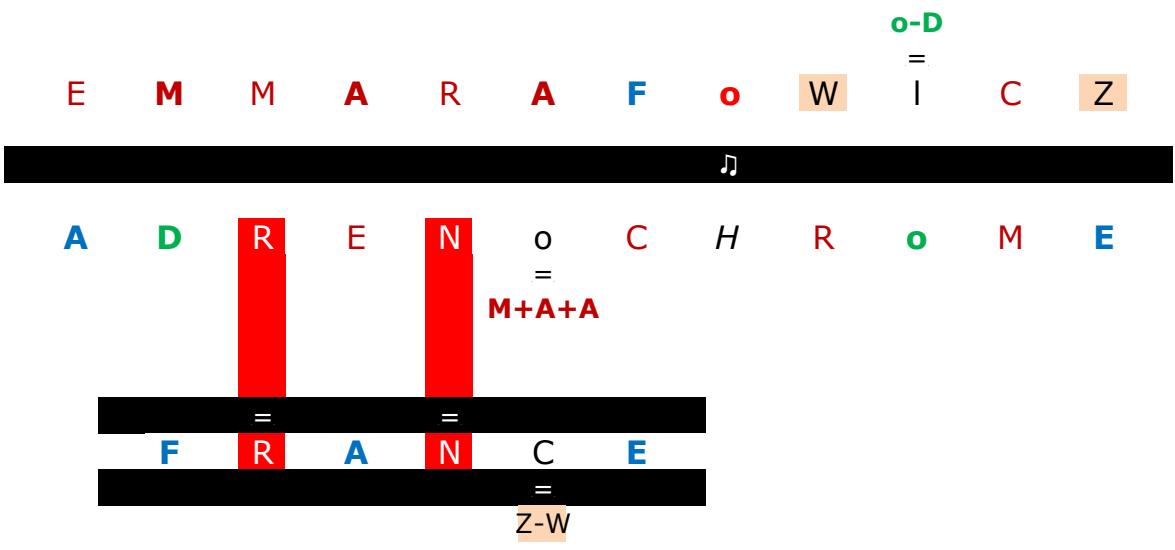

A	B	C	D	E	F	G	H	I	J	K	L	M	N	O	P	Q	R	S	T	U	V	W	X	Y	Z					
↓	↓	↓	↓	↓	↓	↓	↓	↓	↓	↓	↓	↓	↓	↓	↓	↓	↓	↓	↓	↓	↓	↓	↓	↓	↓	↓	↓	↓	↓	
1	2	3	4	5	6	o	7	8	o	o	9	lo	ll	12	13	14	15	16	17	18	19	20	21	22	23					

**E** **V** **E** **I** **Y** **N** **R** **E** **G** **N** **E** **R**

**O**

**A** **D** **R** **E** **N** **O** **C** **H** **R** **O** **M**

E+N+I

= *Joker* = =

**O** **S** **T** **E** **R** **R** **E** **I** **C** **H**

= **8**

Y-V+D-A+M

A	B	C	D	E	F	G	H	I	J	K	L	M	N	O	P	Q	R	S	T	U	V	W	X	Y	Z						
↓	↓	↓	↓	↓	↓	↓	↓	↓	↓	↓	↓	↓	↓	↓	↓	↓	↓	↓	↓	↓	↓	↓	↓	↓	↓	↓	↓	↓	↓	↓	
1	2	3	4	5	6	o	7	8	o	o	9	lo	ll	12	13	14	15	16	17	18	19	20	21	22	23						

**R** **E** **N** **E** **R** **E** **P** **A** **S** **I**

= +

**A** **D** **R** **E** **N** **O** **C** **H** **R** **O** **M**

= = =

**D** **E** **U** **T** **S** **C** **H** **L** **A** **N**+**D**

= = =

R+P-M

I+A

R

A	B	C	D	E	F	G	H	I	J	K	L	M	N	o	P	Q	R	S	T	U	V	W	X	Y	Z
↓	↓	↓	↓	↓	↓	↓	↓	↓	↓	↓	↓	↓	↓	↓	↓	↓	↓	↓	↓	↓	↓	↓	↓	↓	↓
1	2	3	4	5	6	o	7	8	o	o	9	lo	11	12	13	14	15	16	17	18	19	20	21	22	23

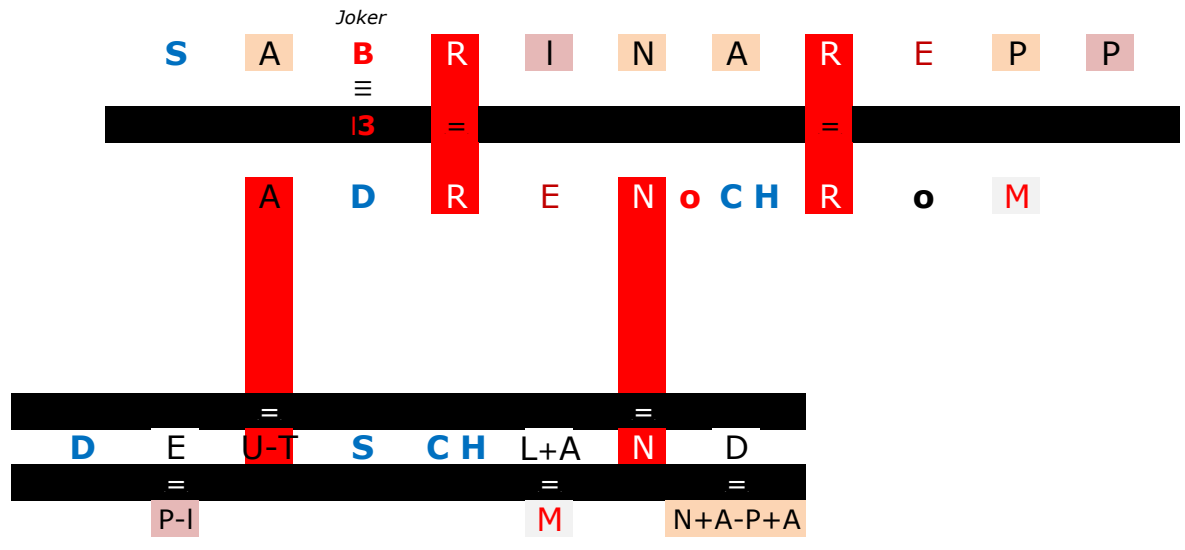

A	B	C	D	E	F	G	H	I	J	K	L	M	N	o	P	Q	R	S	T	U	V	W	X	Y	Z
↓	↓	↓	↓	↓	↓	↓	↓	↓	↓	↓	↓	↓	↓	↓	↓	↓	↓	↓	↓	↓	↓	↓	↓	↓	↓
1	2	3	4	5	6	o	7	8	o	o	9	lo	11	12	13	14	15	16	17	18	19	20	21	22	23

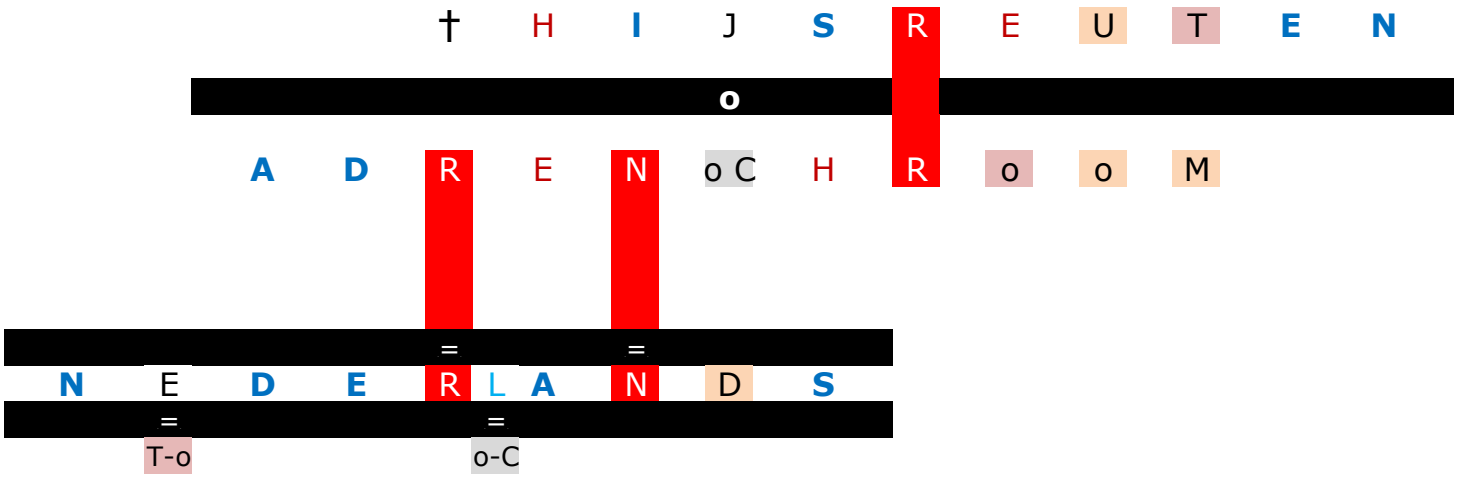

A	B	C	D	E	F	G	H	I	J	K	L	M	N	o	P	Q	R	S	T	U	V	W	X	Y	Z
↓	↓	↓	↓	↓	↓	↓	↓	↓	↓	↓	↓	↓	↓	↓	↓	↓	↓	↓	↓	↓	↓	↓	↓	↓	↓
1	2	3	4	5	6	o	7	8	o	o	9	lo	ll	12	13	14	15	16	17	18	19	20	21	22	23

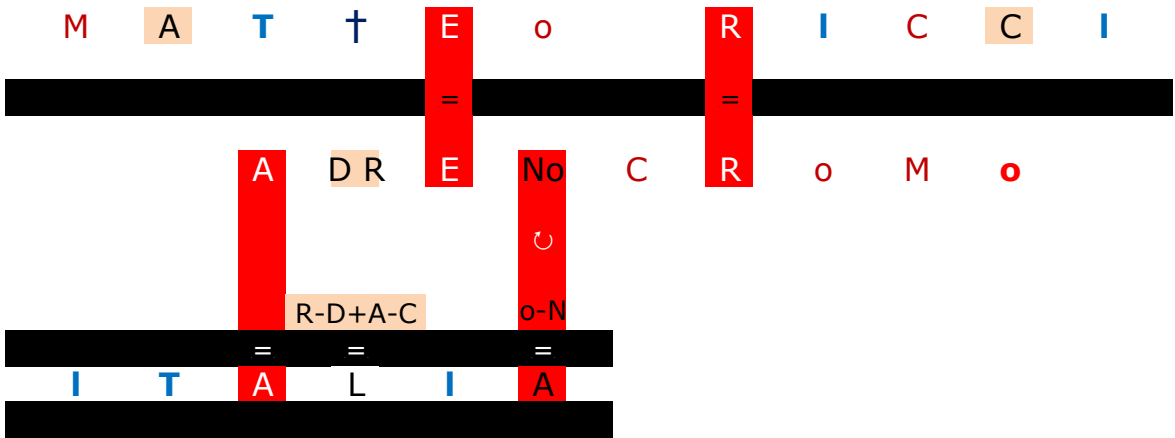

A	B	C	D	E	F	G	H	I	J	K	L	M	N	o	P	Q	R	S	T	U	V	W	X	Y	Z
↓	↓	↓	↓	↓	↓	↓	↓	↓	↓	↓	↓	↓	↓	↓	↓	↓	↓	↓	↓	↓	↓	↓	↓	↓	↓
1	2	3	4	5	6	o	7	8	o	o	9	lo	ll	12	13	14	15	16	17	18	19	20	21	22	23

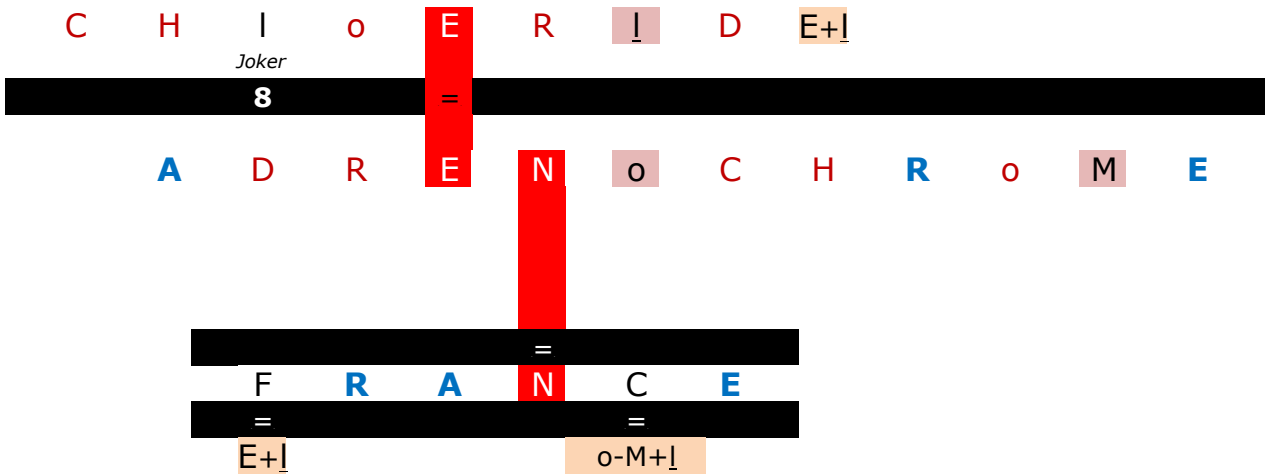

A	B	C	D	E	F	G	H	I	J	K	L	M	N	o	P	Q	R	S	T	U	V	W	X	Y	Z
↓	↓	↓	↓	↓	↓	↓	↓	↓	↓	↓	↓	↓	↓	↓	↓	↓	↓	↓	↓	↓	↓	↓	↓	↓	↓
1	2	3	4	5	6	o	7	8	o	o	9	1o	11	12	13	14	15	16	17	18	19	2o	21	22	23

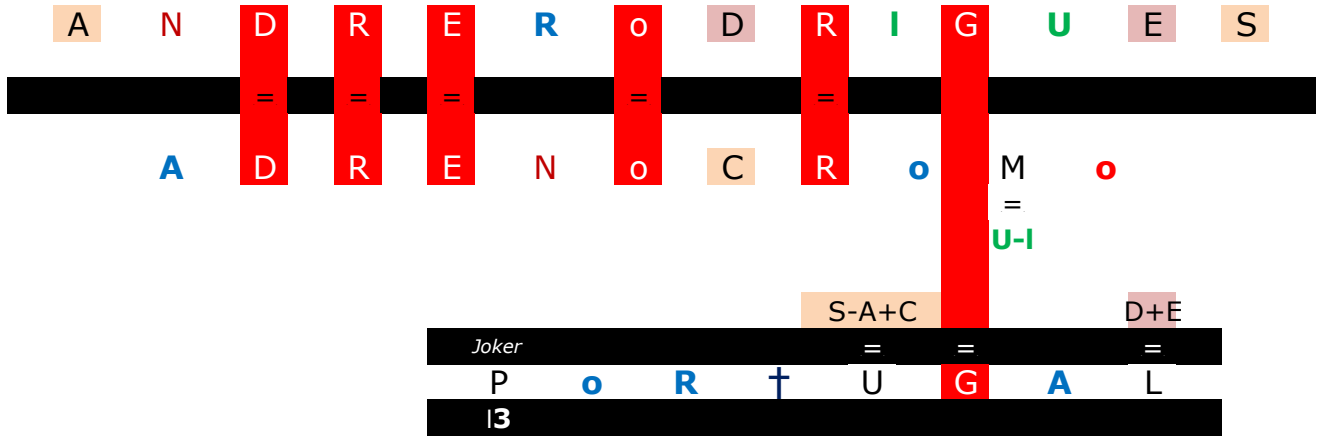

A	B	C	D	E	F	G	H	I	J	K	L	M	N	o	P	Q	R	S	T	U	V	W	X	Y	Z
↓	↓	↓	↓	↓	↓	↓	↓	↓	↓	↓	↓	↓	↓	↓	↓	↓	↓	↓	↓	↓	↓	↓	↓	↓	↓
1	2	3	4	5	6	o	7	8	o	o	9	1o	11	12	13	14	15	16	17	18	19	2o	21	22	23

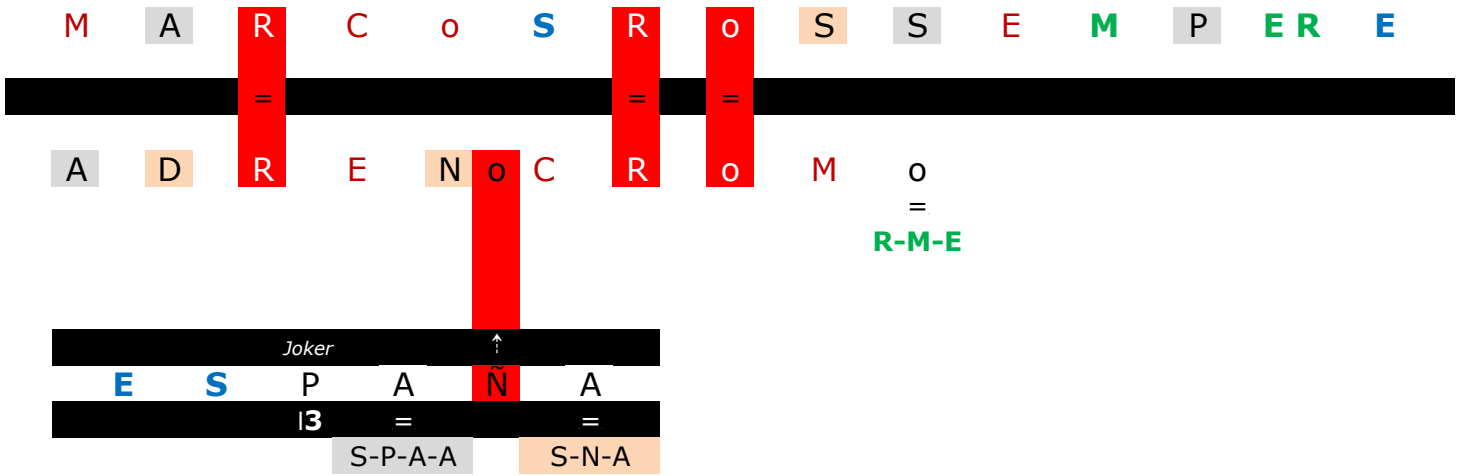

A	B	C	D	E	F	G	H	I	J	K	L	M	N	o	P	Q	R	S	T	U	V	W	X	Y	Z
↓	↓	↓	↓	↓	↓	↓	↓	↓	↓	↓	↓	↓	↓	↓	↓	↓	↓	↓	↓	↓	↓	↓	↓	↓	↓
1	2	3	4	5	6	o	7	8	o	o	9	lo	ll	12	13	14	15	16	17	18	19	20	21	22	23

S A N D R O R U O T O L o

---

A D R E N O C R O M O

S-E-C

---

I T A L I A

---

U-M

A	B	C	D	E	F	G	H	I	J	K	L	M	N	o	P	Q	R	S	T	U	V	W	X	Y	Z
↓	↓	↓	↓	↓	↓	↓	↓	↓	↓	↓	↓	↓	↓	↓	↓	↓	↓	↓	↓	↓	↓	↓	↓	↓	↓
1	2	3	4	5	6	o	7	8	o	o	9	lo	ll	12	13	14	15	16	17	18	19	20	21	22	23

N A C H O S A N C H E Z A M o R

---

A D R E N O C R O M o

E S P A N A

---

R-A+C-A-N Z-H-H+D

A	B	C	D	E	F	G	H	I	J	K	L	M	N	o	P	Q	R	S	T	U	V	W	X	Y	Z
↓	↓	↓	↓	↓	↓	↓	↓	↓	↓	↓	↓	↓	↓	↓	↓	↓	↓	↓	↓	↓	↓	↓	↓	↓	↓
1	2	3	4	5	6	o	7	8	o	o	9	1o	11	12	13	14	15	16	17	18	19	2o	21	22	23

R-D

=

E L E N A S A N C H O M U R I L-L o



A D R E N O C R o M o

L-L



E S P A N A

U+A-H+A

L-I

A	B	C	D	E	F	G	H	I	J	K	L	M	N	o	P	Q	R	S	T	U	V	W	X		
↓	↓	↓	↓	↓	↓	↓	↓	↓	↓	↓	↓	↓	↓	↓	↓	↓	↓	↓	↓	↓	↓	↓	↓	↓	↓
1	2	3	4	5	6	o	7	8	o	o	9	1o	11	12	13	14	15	16	17	18	19	2o	21	22	23

E R I C S-A R G I A C O M o

Joker



A+D R E N o C H R O M E

S-A



F R A N C E

A	B	C	D	E	F	G	H	I	J	K	L	M	N	o	P	Q	R	S	T	U	V	W	X	Y	Z
↓	↓	↓	↓	↓	↓	↓	↓	↓	↓	↓	↓	↓	↓	↓	↓	↓	↓	↓	↓	↓	↓	↓	↓	↓	↓
1	2	3	4	5	6	o	7	8	o	o	9	1o	11	12	13	14	15	16	17	18	19	2o	21	22	23

C H R I S T E ! S C H A ! D E M o S E



A D R E N o K R o M  
 ↓  
 !! CHES-CHES

D A N-M A R K  
 = = =  
 o-l A T-S

A	B	C	D	E	F	G	H	I	J	K	L	M	N	o	P	Q	R	S	T	U	V	W	X	Y	Z
↓	↓	↓	↓	↓	↓	↓	↓	↓	↓	↓	↓	↓	↓	↓	↓	↓	↓	↓	↓	↓	↓	↓	↓	↓	↓
1	2	3	4	5	6	o	7	8	o	o	9	1o	11	12	13	14	15	16	17	18	19	2o	21	22	23

J o A N N A S C H E U R I N G W I E L G U S  
 R-E



A D R E N o C H R o M  
 = =  
 W-S GUN-GUN

Joker  
 P o L S K A  
 13  
 |-|



A	B	C	D	E	F	G	H	I	J	K	L	M	N	o	P	Q	R	S	T	U	V	W	X	Y	Z
↓	↓	↓	↓	↓	↓	↓	↓	↓	↓	↓	↓	↓	↓	↓	↓	↓	↓	↓	↓	↓	↓	↓	↓	↓	↓
1	2	3	4	5	6	o	7	8	o	o	9	lo	ll	12	13	14	15	16	17	18	19	20	21	22	23

G U N T H E R S I I D

o =

A D R E N o C H R o M

↓  
I

=

o S † E R R - E + I C H

=

T-o

U-M-I

A	B	C	D	E	F	G	H	I	J	K	L	M	N	o	P	Q	R	S	T	U	V	W	X	Y	Z
↓	↓	↓	↓	↓	↓	↓	↓	↓	↓	↓	↓	↓	↓	↓	↓	↓	↓	↓	↓	↓	↓	↓	↓	↓	↓
1	2	3	4	5	6	o	7	8	o	o	9	lo	ll	12	13	14	15	16	17	18	19	20	21	22	23

B I R G I T S I P P E L

o

A D R E N o C H R o M

P-I

=

D E U T S C H L A N D

=

R+A+B

↓  
I

P+I-M

A	B	C	D	E	F	G	H	I	J	K	L	M	N	o	P	Q	R	S	T	U	V	W	X	Y	Z
↓	↓	↓	↓	↓	↓	↓	↓	↓	↓	↓	↓	↓	↓	↓	↓	↓	↓	↓	↓	↓	↓	↓	↓	↓	↓
1	2	3	4	5	6	o	7	8	o	o	9	lo	ll	12	13	14	15	16	17	18	19	20	21	22	23

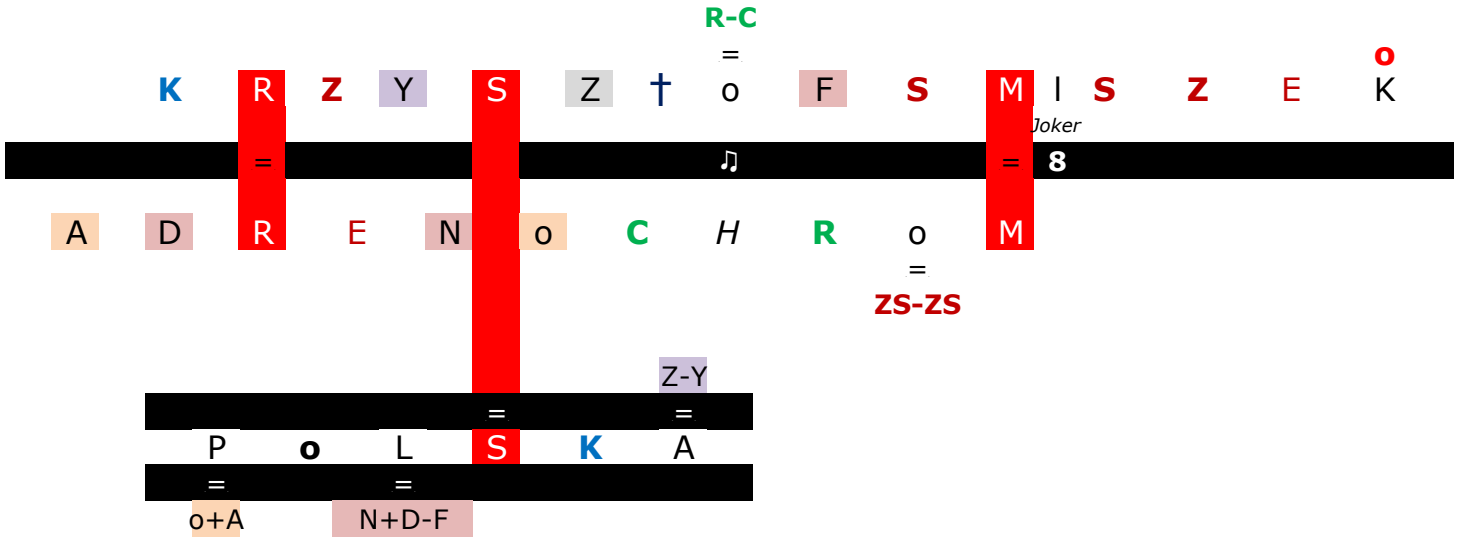

A	B	C	D	E	F	G	H	I	J	K	L	M	N	o	P	Q	R	S	T	U	V	W	X	Y	Z
↓	↓	↓	↓	↓	↓	↓	↓	↓	↓	↓	↓	↓	↓	↓	↓	↓	↓	↓	↓	↓	↓	↓	↓	↓	↓
1	2	3	4	5	6	o	7	8	o	o	9	lo	ll	12	13	14	15	16	17	18	19	20	21	22	23

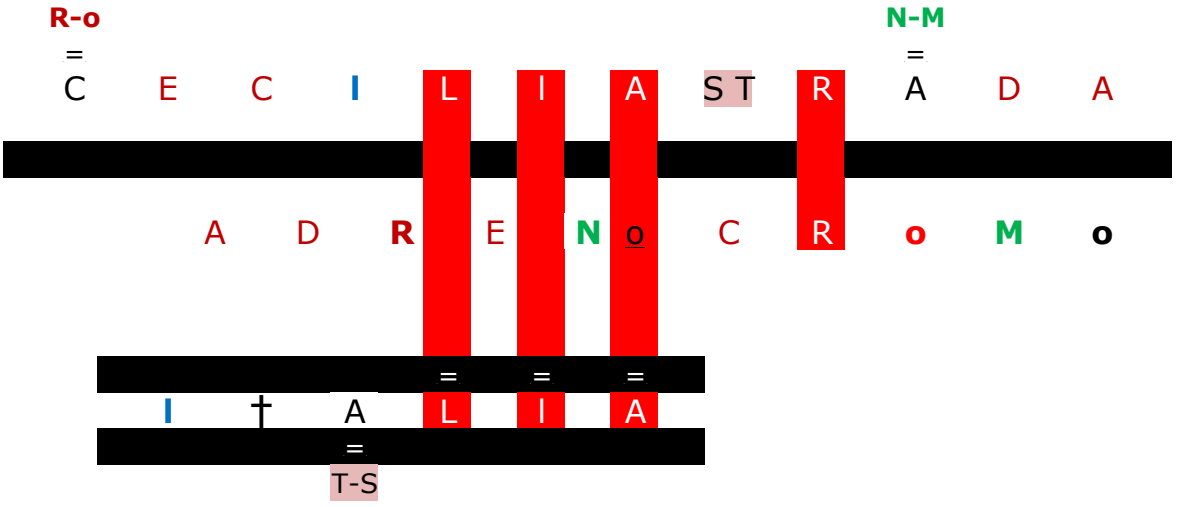

A	B	C	D	E	F	G	H	I	J	K	L	M	N	o	P	Q	R	S	T	U	V	W	X	Y	Z
↓	↓	↓	↓	↓	↓	↓	↓	↓	↓	↓	↓	↓	↓	↓	↓	↓	↓	↓	↓	↓	↓	↓	↓	↓	↓
I	2	3	4	5	6	o	7	8	o	o	9	lo	ll	12	13	14	15	16	17	18	19	20	2l	22	23

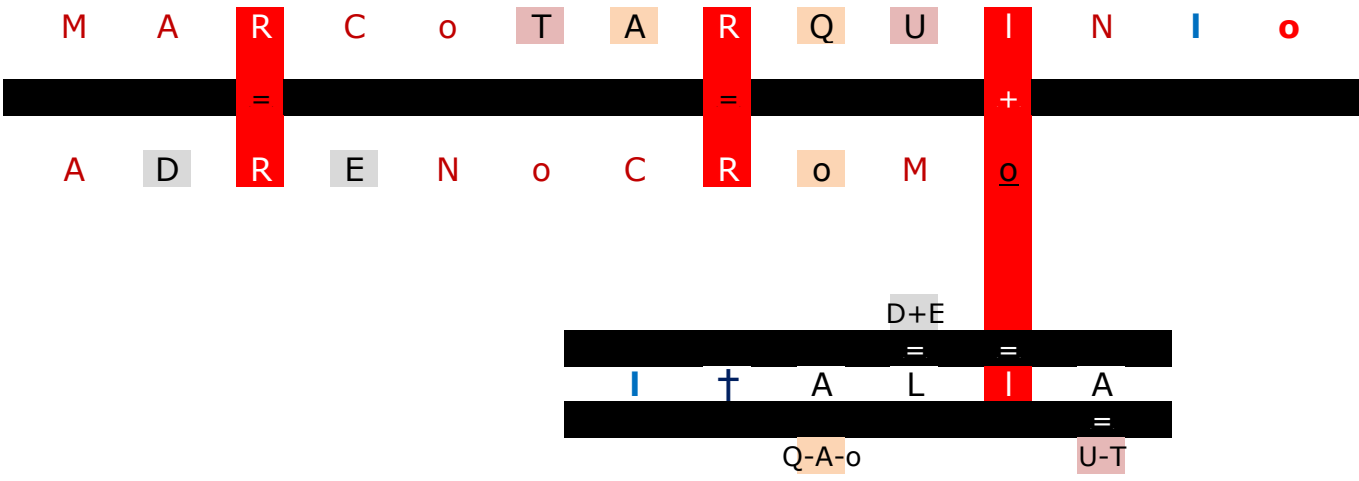

A	B	C	D	E	F	G	H	I	J	K	L	M	N	o	P	Q	R	S	T	U	V	W	X	Y	Z
↓	↓	↓	↓	↓	↓	↓	↓	↓	↓	↓	↓	↓	↓	↓	↓	↓	↓	↓	↓	↓	↓	↓	↓	↓	↓
I	2	3	4	5	6	o	7	8	o	o	9	lo	ll	12	13	14	15	16	17	18	19	20	2l	22	23

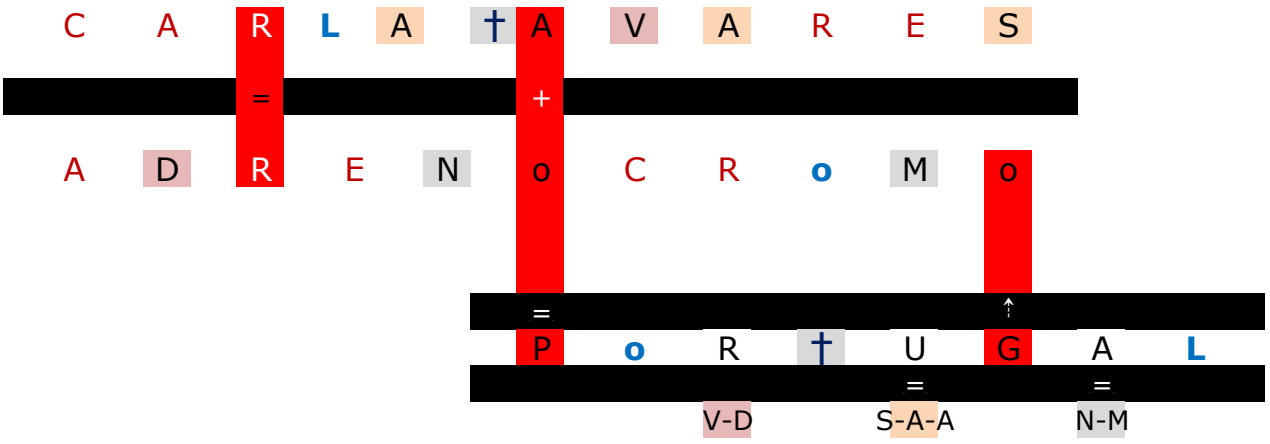

A	B	C	D	E	F	G	H	I	J	K	L	M	N	o	P	Q	R	S	T	U	V	W	X	Y	Z
↓	↓	↓	↓	↓	↓	↓	↓	↓	↓	↓	↓	↓	↓	↓	↓	↓	↓	↓	↓	↓	↓	↓	↓	↓	↓
1	2	3	4	5	6	o	7	8	o	o	9	lo	ll	12	13	14	15	16	17	18	19	20	21	22	23

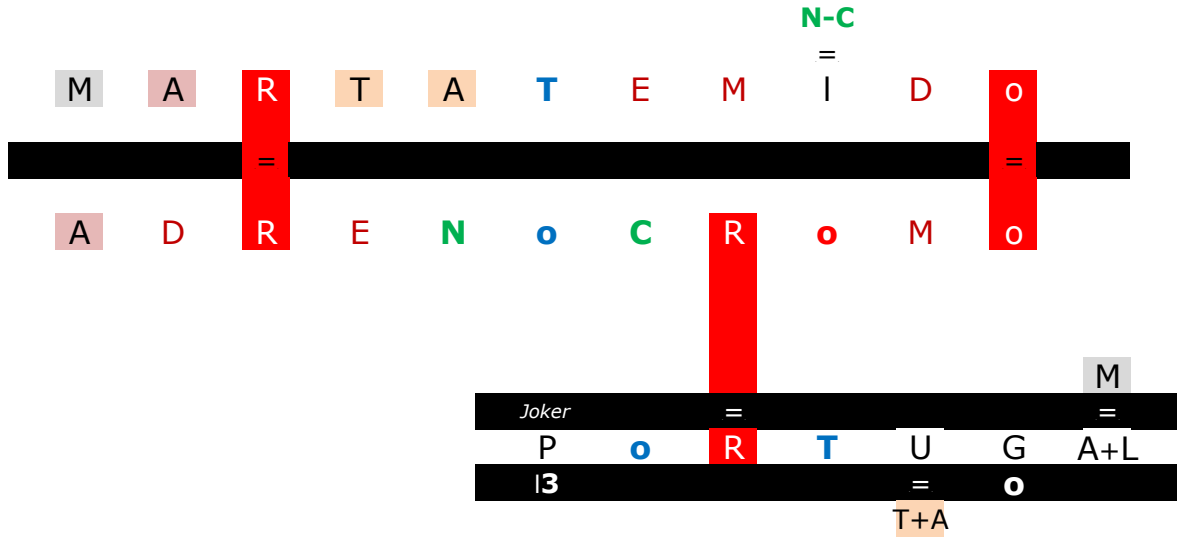

A	B	C	D	E	F	G	H	I	J	K	L	M	N	o	P	Q	R	S	T	U	V	W	X	Y	Z
↓	↓	↓	↓	↓	↓	↓	↓	↓	↓	↓	↓	↓	↓	↓	↓	↓	↓	↓	↓	↓	↓	↓	↓	↓	↓
1	2	3	4	5	6	o	7	8	o	o	9	lo	ll	12	13	14	15	16	17	18	19	20	21	22	23

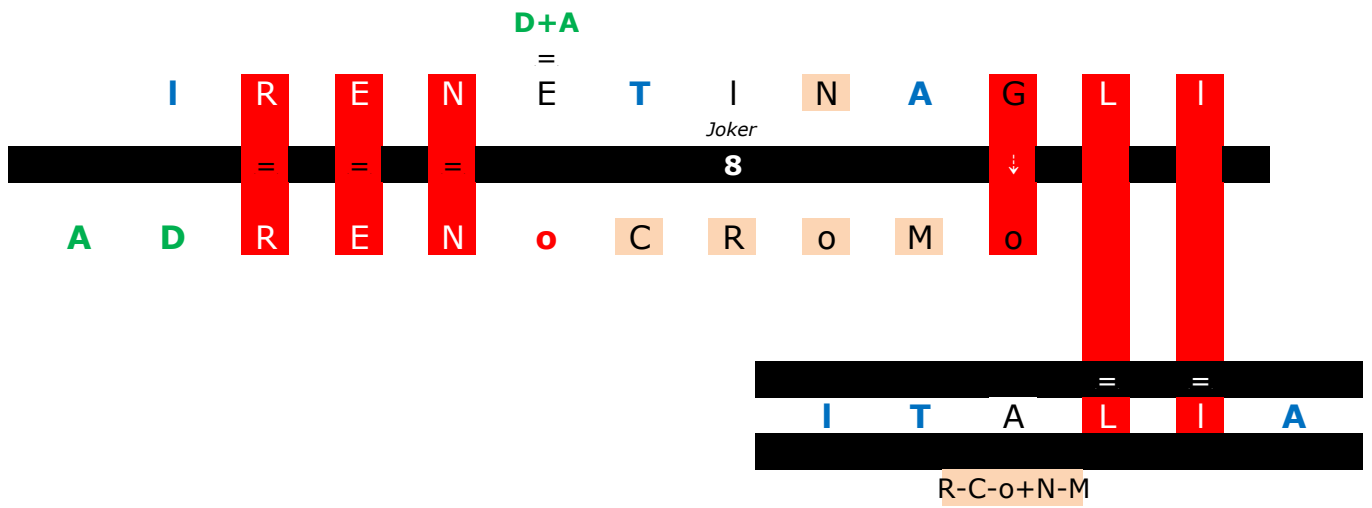

A	B	C	D	E	F	G	H	I	J	K	L	M	N	o	P	Q	R	S	T	U	V	W	X	Y	Z
↓	↓	↓	↓	↓	↓	↓	↓	↓	↓	↓	↓	↓	↓	↓	↓	↓	↓	↓	↓	↓	↓	↓	↓	↓	↓
I	2	3	4	5	6	o	7	8	o	o	9	lo	ll	12	13	14	15	16	17	18	19	20	2l	22	23

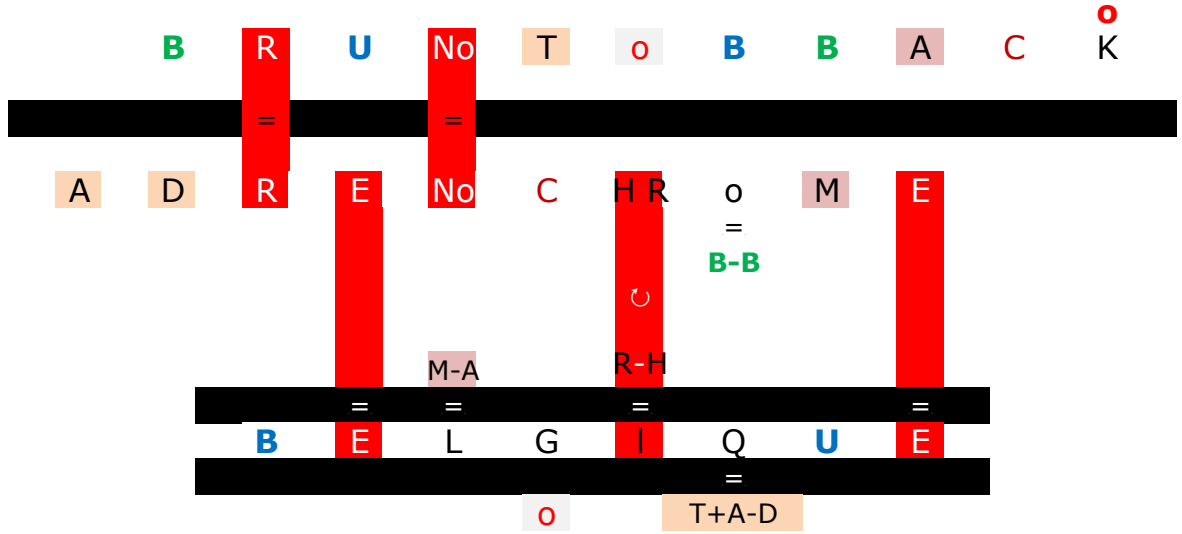

A	B	C	D	E	F	G	H	I	J	K	L	M	N	o	P	Q	R	S	T	U	V	W	X	Y	Z
↓	↓	↓	↓	↓	↓	↓	↓	↓	↓	↓	↓	↓	↓	↓	↓	↓	↓	↓	↓	↓	↓	↓	↓	↓	↓
I	2	3	4	5	6	o	7	8	o	o	9	lo	ll	12	13	14	15	16	17	18	19	20	2l	22	23

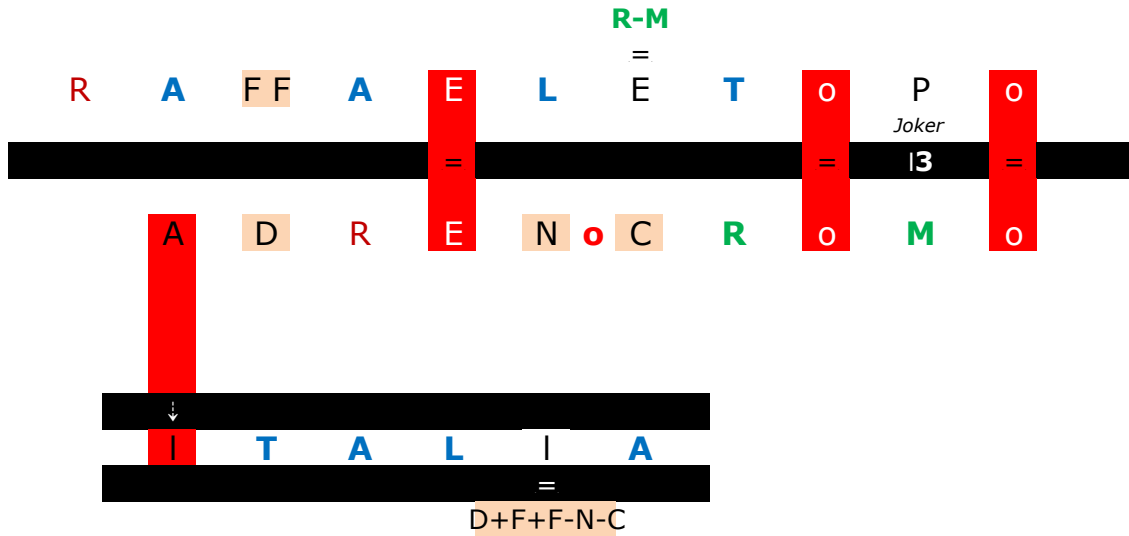

A	B	C	D	E	F	G	H	I	J	K	L	M	N	o	P	Q	R	S	T	U	V	W	X	Y	Z
↓	↓	↓	↓	↓	↓	↓	↓	↓	↓	↓	↓	↓	↓	↓	↓	↓	↓	↓	↓	↓	↓	↓	↓	↓	↓
1	2	3	4	5	6	o	7	8	o	o	9	lo	ll	12	13	14	15	16	17	18	19	20	21	22	23

M I H A I † U D o S E

A D R E N o C  
= U-M-I

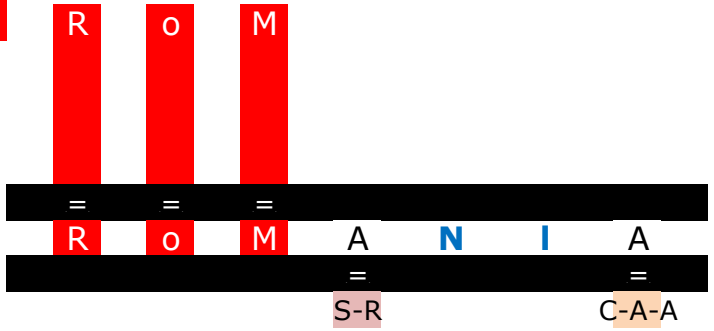

A	B	C	D	E	F	G	H	I	J	K	L	M	N	o	P	Q	R	S	T	U	V	W	X	Y	Z
↓	↓	↓	↓	↓	↓	↓	↓	↓	↓	↓	↓	↓	↓	↓	↓	↓	↓	↓	↓	↓	↓	↓	↓	↓	↓
1	2	3	4	5	6	o	7	8	o	o	9	lo	ll	12	13	14	15	16	17	18	19	20	21	22	23

R+M-C-H-R

N I L S U S A K o V S

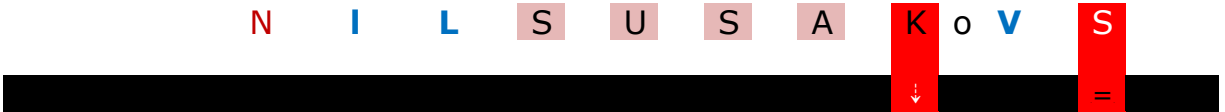

A D R E N o C H R o M S

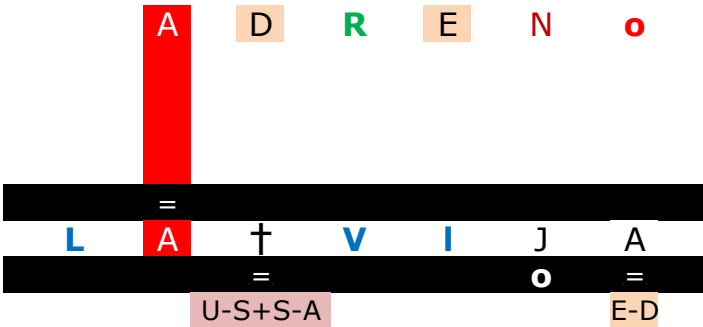

A	B	C	D	E	F	G	H	I	J	K	L	M	N	O	P	Q	R	S	T	U	V	W	X	Y	Z
↓	↓	↓	↓	↓	↓	↓	↓	↓	↓	↓	↓	↓	↓	↓	↓	↓	↓	↓	↓	↓	↓	↓	↓	↓	↓
1	2	3	4	5	6	o	7	8	o	o	9	lo	ll	12	13	14	15	16	17	18	19	20	21	22	23

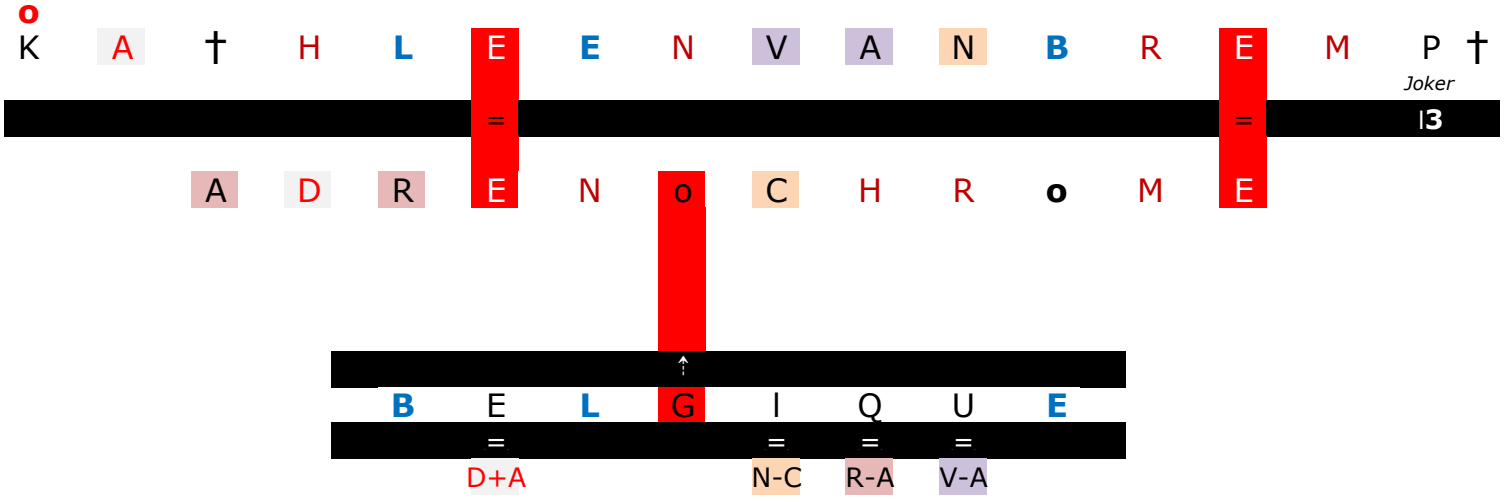

A	B	C	D	E	F	G	H	I	J	K	L	M	N	O	P	Q	R	S	T	U	V	W	X	Y	Z
↓	↓	↓	↓	↓	↓	↓	↓	↓	↓	↓	↓	↓	↓	↓	↓	↓	↓	↓	↓	↓	↓	↓	↓	↓	↓
1	2	3	4	5	6	o	7	8	o	o	9	lo	ll	12	13	14	15	16	17	18	19	20	21	22	23

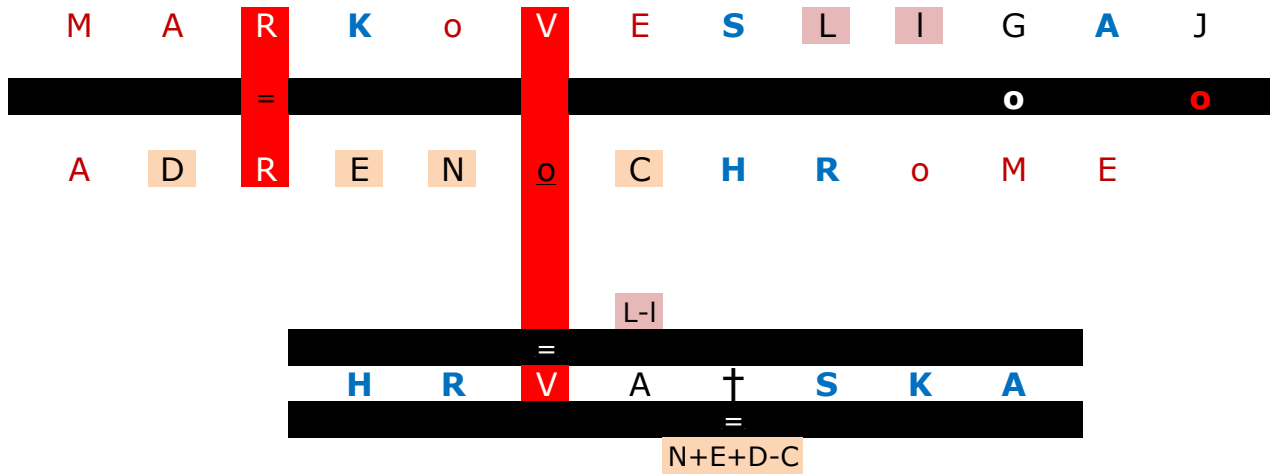

A	B	C	D	E	F	G	H	I	J	K	L	M	N	o	P	Q	R	S	T	U	V	W	X	Y	Z
↓	↓	↓	↓	↓	↓	↓	↓	↓	↓	↓	↓	↓	↓	↓	↓	↓	↓	↓	↓	↓	↓	↓	↓	↓	↓
1	2	3	4	5	6	o	7	8	o	o	9	1o	11	12	13	14	15	16	17	18	19	2o	21	22	23

K R I S † I A N V I G E N I N



A D R E N o K H R o M  
 =  
 N-N

E+D+A+I

=  
 B U L G A R E S K I  
 =  
 I+I V-M

A	B	C	D	E	F	G	H	I	J	K	L	M	N	o	P	Q	R	S	T	U	V	W	X	Y	Z
↓	↓	↓	↓	↓	↓	↓	↓	↓	↓	↓	↓	↓	↓	↓	↓	↓	↓	↓	↓	↓	↓	↓	↓	↓	↓
1	2	3	4	5	6	o	7	8	o	o	9	1o	11	12	13	14	15	16	17	18	19	2o	21	22	23

M A R I A N N E V I N D



A D R E N o K R o M  
 =  
 A+N

I-o

=  
 D A N M A R K  
 =  
 V-I

A	B	C	D	E	F	G	H	I	J	K	L	M	N	o	P	Q	R	S	T	U	V	W	X	Y	Z
↓	↓	↓	↓	↓	↓	↓	↓	↓	↓	↓	↓	↓	↓	↓	↓	↓	↓	↓	↓	↓	↓	↓	↓	↓	↓
I	2	3	4	5	6	o	7	8	o	o	9	lo	ll	12	13	14	15	16	17	18	19	20	21	22	23

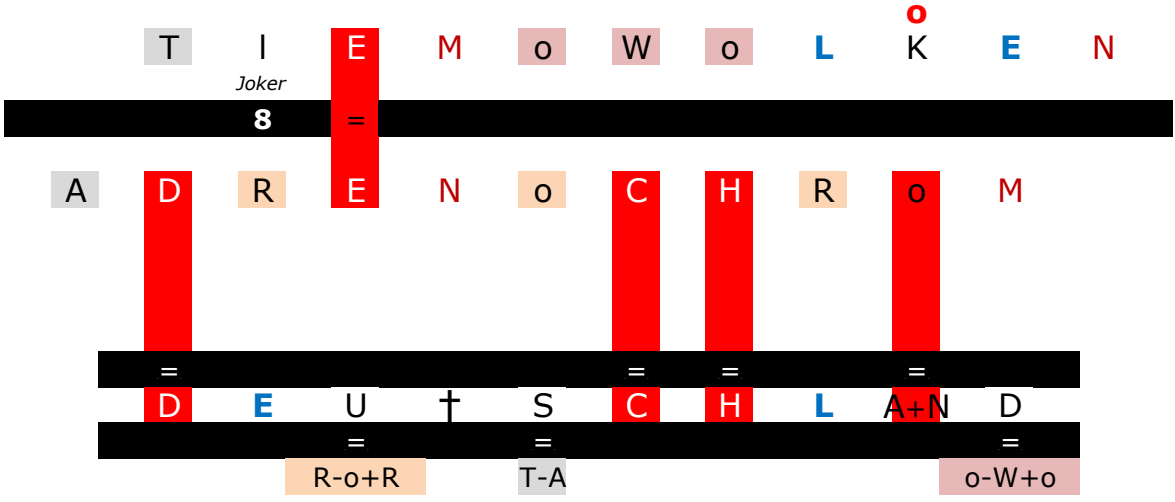

A	B	C	D	E	F	G	H	I	J	K	L	M	N	o	P	Q	R	S	T	U	V	W	X	Y	Z
↓	↓	↓	↓	↓	↓	↓	↓	↓	↓	↓	↓	↓	↓	↓	↓	↓	↓	↓	↓	↓	↓	↓	↓	↓	↓
I	2	3	4	5	6	o	7	8	o	o	9	lo	ll	12	13	14	15	16	17	18	19	20	21	22	23

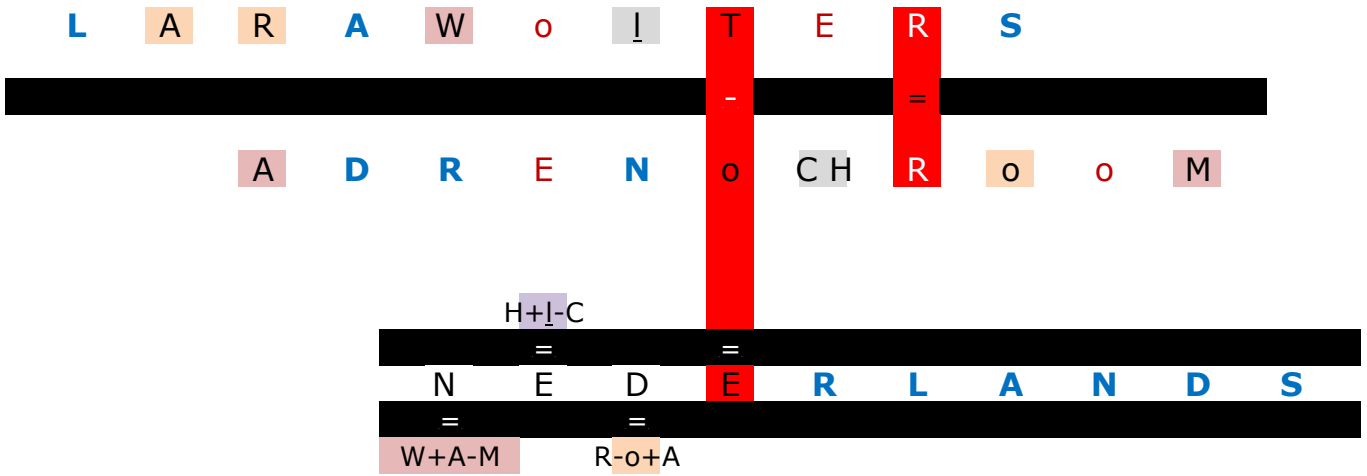

A	B	C	D	E	F	G	H	I	J	K	L	M	N	o	P	Q	R	S	T	U	V	W	X	Y	Z
↓	↓	↓	↓	↓	↓	↓	↓	↓	↓	↓	↓	↓	↓	↓	↓	↓	↓	↓	↓	↓	↓	↓	↓	↓	↓
1	2	3	4	5	6	o	7	8	o	o	9	lo	11	12	13	14	15	16	17	18	19	20	21	22	23

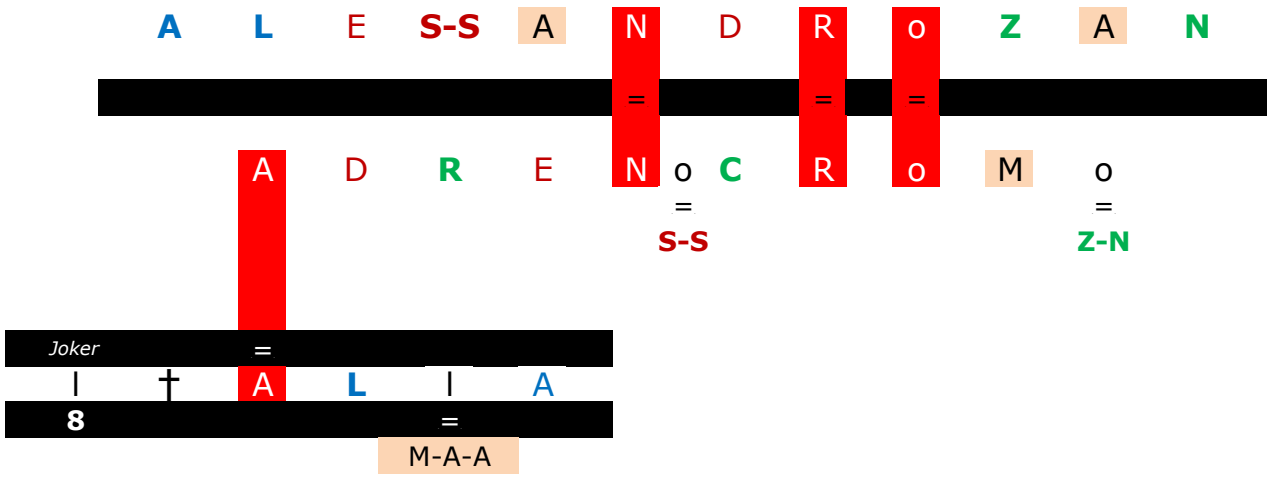

A	B	C	D	E	F	G	H	I	J	K	L	M	N	o	P	Q	R	S	T	U	V	W	X	Y	Z
↓	↓	↓	↓	↓	↓	↓	↓	↓	↓	↓	↓	↓	↓	↓	↓	↓	↓	↓	↓	↓	↓	↓	↓	↓	↓
1	2	3	4	5	6	o	7	8	o	o	9	lo	11	12	13	14	15	16	17	18	19	20	21	22	23

